



INTERNATIONAL APPLICATION PUBLISHED UNDER THE PATENT COOPERATION TREATY (PCT)

<p>(51) International Patent Classification ⁶ : A61K 9/16, 9/70, A61L 31/00, A61K 31/20, 31/335, 38/57</p>	<p>A1</p>	<p>(11) International Publication Number: WO 95/03036 (43) International Publication Date: 2 February 1995 (02.02.95)</p>
<p>(21) International Application Number: PCT/CA94/00373 (22) International Filing Date: 19 July 1994 (19.07.94) (30) Priority Data: 08/094,536 19 July 1993 (19.07.93) US (71) Applicant (for all designated States except US): ANGIOGENESIS TECHNOLOGIES, INC. [CA/CA]; Suite 2120 Oceanic Plaza, 1066 West Hastings Street, Vancouver, British Columbia V6E 3X1 (CA). (71)(72) Applicant and Inventor: BURT, Helen, M. [CA/CA]; 240 East 40th Avenue, Vancouver, British Columbia V5W 1L8 (CA). (72) Inventors; and (75) Inventors/Applicants (for US only): HUNTER, William, L. [CA/CA]; 525 North Penticton Street, Vancouver, British Columbia V5K 3L7 (CA). MACHAN, Lindsay, S. [CA/CA]; 2529B Point Grey Road, Vancouver, British Columbia V6K 1A1 (CA). ARSENAULT, A., Larry [CA/CA]; RR #1, Paris, Ontario N3L 3E1 (CA).</p>	<p>(74) Agents: NASSIF, Omar, A. et al.; McCarthy Tétrault, Suite 4700, Toronto Dominion Bank Tower, Toronto-Dominion Centre, Toronto, Ontario M5K 1E6 (CA). (81) Designated States: AM, AT, AU, BB, BG, BR, BY, CA, CH, CN, CZ, DE, DK, ES, FI, GB, GE, HU, JP, KE, KG, KP, KR, KZ, LK, LT, LU, LV, MD, MG, MN, MW, NL, NO, NZ, PL, PT, RO, RU, SD, SE, SI, SK, TJ, TT, UA, US, UZ, VN, European patent (AT, BE, CH, DE, DK, ES, FR, GB, GR, IE, IT, LU, MC, NL, PT, SE), OAPI patent (BF, BJ, CF, CG, CI, CM, GA, GN, ML, MR, NE, SN, TD, TG), ARIPO patent (KE, MW, SD). Published <i>With international search report. Before the expiration of the time limit for amending the claims and to be republished in the event of the receipt of amendments.</i></p>	
<p>(54) Title: ANTI-ANGIOGENIC COMPOSITIONS AND METHODS OF USE</p>		
<p>(57) Abstract</p> <p>The present invention provides compositions comprising an anti-angiogenic factor, and a polymeric carrier. Representative examples of anti-angiogenic factors include Anti-Invasive Factor, Retinoic acids and derivatives thereof, and taxol. Also provided are methods for embolizing blood vessels, and eliminating biliary, urethral, esophageal, and tracheal/bronchial obstructions.</p>		

FOR THE PURPOSES OF INFORMATION ONLY

Codes used to identify States party to the PCT on the front pages of pamphlets publishing international applications under the PCT.

AT	Austria	GB	United Kingdom	MR	Mauritania
AU	Australia	GE	Georgia	MW	Malawi
BB	Barbados	GN	Guinea	NE	Niger
BE	Belgium	GR	Greece	NL	Netherlands
BF	Burkina Faso	HU	Hungary	NO	Norway
BG	Bulgaria	IE	Ireland	NZ	New Zealand
BJ	Benin	IT	Italy	PL	Poland
BR	Brazil	JP	Japan	PT	Portugal
BY	Belarus	KE	Kenya	RO	Romania
CA	Canada	KG	Kyrgyzstan	RU	Russian Federation
CF	Central African Republic	KP	Democratic People's Republic of Korea	SD	Sudan
CG	Congo	KR	Republic of Korea	SE	Sweden
CH	Switzerland	KZ	Kazakhstan	SI	Slovenia
CI	Côte d'Ivoire	LI	Liechtenstein	SK	Slovakia
CM	Cameroon	LK	Sri Lanka	SN	Senegal
CN	China	LU	Luxembourg	TD	Chad
CS	Czechoslovakia	LV	Latvia	TG	Togo
CZ	Czech Republic	MC	Monaco	TJ	Tajikistan
DE	Germany	MD	Republic of Moldova	TT	Trinidad and Tobago
DK	Denmark	MG	Madagascar	UA	Ukraine
ES	Spain	ML	Mali	US	United States of America
FI	Finland	MN	Mongolia	UZ	Uzbekistan
FR	France			VN	Viet Nam
GA	Gabon				

Description

ANTI-ANGIOGENIC COMPOSITIONS AND METHODS OF USE

5 Technical Field

The present invention relates generally to compositions and methods for treating cancer and other angiogenic-dependent diseases, and more specifically, to compositions comprising anti-angiogenic factors and polymeric carriers, stents which have been coated with such compositions, as well as
10 methods for utilizing these stents and compositions.

Background Of The Invention

Cancer is the second leading cause of death in the United States, and accounts for over one fifth of the total mortality. Briefly, cancer is
15 characterized by the uncontrolled division of a population of cells which, most typically, leads to the formation of one or more tumors. Although cancer is generally more readily diagnosed than in the past, many forms, even if detected early, are still incurable.

A variety of methods are presently utilized to treat cancer,
20 including for example various surgical procedures. If treated with surgery alone, however, many patients (particularly those with certain types of cancer, such as breast, brain, colon and hepatic cancer) will experience recurrence of the cancer. In addition to surgery, many cancers are also treated with a combination of therapies involving cytotoxic chemotherapeutic drugs (e.g.,
25 vincristine, vinblastine, cisplatin, methotrexate, 5-FU, etc.) and/or radiation therapy. One difficulty with this approach, however, is that radiotherapeutic and chemotherapeutic agents are toxic to normal tissues, and often create life-threatening side effects. In addition, these approaches often have extremely high failure/remission rates.

30 In addition to surgical, chemo and radiation therapies, others have attempted to utilize an individual's own immune system in order to eliminate cancerous cells. For example, some have suggested the use of bacterial or viral components as adjuvants in order to stimulate the immune system to destroy tumor cells. (*See generally* "Principles of Cancer Biotherapy," Oldham (ed.),
35 Raven Press, New York, 1987.) Such agents have generally been useful as adjuvants and as nonspecific stimulants in animal tumor models, but have not as of yet proved to be generally effective in humans.

Lymphokines have also been utilized in the treatment of cancer. Briefly, lymphokines are secreted by a variety of cells, and generally have an effect on specific cells in the generation of an immune response. Examples of lymphokines include Interleukins (IL)-1, -2, -3, and -4, as well as colony stimulating factors such as G-CSF, GM-CSF, and M-CSF. Recently, one group has
5 utilized IL-2 to stimulate peripheral blood cells in order to expand and produce large quantities of cells which are cytotoxic to tumor cells (Rosenberg et al., *N. Engl. J. Med.* 313:1485-1492, 1985).

Others have suggested the use of antibodies in the treatment of
10 cancer. Briefly, antibodies may be developed which recognize certain cell surface antigens that are either unique, or more prevalent on cancer cells compared to normal cells. These antibodies, or "magic bullets," may be utilized either alone or conjugated with a toxin in order to specifically target and kill tumor cells (Dillman, "Antibody Therapy," *Principles of Cancer Biotherapy*,
15 Oldham (ed.), Raven Press, Ltd., New York, 1987). However, one difficulty is that most monoclonal antibodies are of murine origin, and thus hypersensitivity against the murine antibody may limit its efficacy, particularly after repeated therapies. Common side effects include fever, sweats and chills, skin rashes, arthritis, and nerve palsies.

20 One additional difficulty of present methods is that local recurrence and local disease control remains a major challenge in the treatment of malignancy. In particular, a total of 630,000 patients annually (in the U.S.) have localized disease (no evidence of distant metastatic spread) at the time of presentation; this represents 64% of all those patients diagnosed with
25 malignancy (this does not include nonmelanoma skin cancer or carcinoma *in situ*). For the vast majority of these patients, surgical resection of the disease represents the greatest chance for a cure and indeed 428,000 will be cured after the initial treatment - 428,000. Unfortunately, 202,000 (or 32% of all patients with localized disease) will relapse after the initial treatment. Of those who
30 relapse, the number who will relapse due to local recurrence of the disease amounts to 133,000 patients annually (or 21% of all those with localized disease). The number who will relapse due to distant metastases of the disease is 68,000 patients annually (11% of all those with localized disease). Another 102,139 patients annually will die as a direct result of an inability to control the
35 local growth of the disease.

Nowhere is this problem more evident than in breast cancer, which affects 186,000 women annually in the U.S. and whose mortality rate has

remained unchanged for 50 years. Surgical resection of the disease through radical mastectomy, modified radical mastectomy, or lumpectomy remains the mainstay of treatment for this condition. Unfortunately, 39% of those treated with lumpectomy alone will develop a local recurrence of the disease, and
5 surprisingly, so will 25% of those in which the resection margin is found to be clear of tumor histologically. As many as 90% of these local recurrences will occur within 2 cm of the previous excision site.

Similarly, in 1991, over 113,000 deaths and 238,600 new cases of liver metastasis were reported in North America alone. The mean survival time
10 for patients with liver metastases is only 6.6 months once liver lesions have developed. Non-surgical treatment for hepatic metastases include systemic chemotherapy, radiation, chemoembolization, hepatic arterial chemotherapy, and intraarterial radiation. However, despite evidence that such treatments can transiently decrease the size of the hepatic lesions (*e.g.*, systemic chemotherapy
15 and hepatic arterial chemotherapy initially reduces lesions in 15-20%, and 80% of patients, respectively), the lesions invariably reoccur. Surgical resection of liver metastases represents the only possibility for a cure, but such a procedure is possible in only 5% of patients with metastases, and in only 15-20% of patients with primary hepatic cancer.

20 One method that has been attempted for the treatment of tumors with limited success is therapeutic embolization. Briefly, blood vessels which nourish a tumor are deliberately blocked by injection of an embolic material into the vessels. A variety of materials have been attempted in this regard, including autologous substances such as fat, blood clot, and chopped muscle
25 fragments, as well as artificial materials such as wool, cotton, steel balls, plastic or glass beads, tantalum powder, silicone compounds, radioactive particles, sterile absorbable gelatin sponge (Sterispon, Gelfoam), oxidized cellulose (Oxycel), steel coils, alcohol, lyophilized human dura mater (Lyodura), microfibrillar collagen (Avitene), collagen fibrils (Tachotop), polyvinyl alcohol
30 sponge (PVA; Ivalon), Barium-impregnated silicon spheres (Biss) and detachable balloons. The size of liver metastases may be temporarily decreased utilizing such methods, but tumors typically respond by causing the growth of new blood vessels into the tumor.

A related problem to tumor formation is the development of
35 cancerous blockages which inhibit the flow of material through body passageways, such as the bile ducts, trachea, esophagus, vasculature and urethra. One device, the stent, has been developed in order to hold open passageways

which have been blocked by tumors or other substances. Representative examples of common stents include the Wallstent, Strecker stent, Gianturco stent and the Palmaz stent. The major problem with stents, however, is that they do not prevent the ingrowth of tumor or inflammatory material through the interstices of the stent. If this material reaches the inside of a stent and compromises the stent lumen, it may result in blockage of the body passageway into which it has been inserted. In addition, presence of a stent in the body may induce reactive or inflammatory tissue (e.g., blood vessels, fibroblasts, white blood cells) to enter the stent lumen, resulting in partial or complete closure of the stent.

The present invention provides compositions and methods suitable for treating cancers and other angiogenesis-dependent diseases which address the problems associated with the procedures discussed above, and further provides other related advantages.

Summary of the Invention

Briefly stated, the present invention provides anti-angiogenic compositions, as well as methods and devices which utilize such compositions for the treatment of cancer and other angiogenesis-dependent diseases. Within one aspect of the present invention, compositions are provided (hereinafter referred to as "anti-angiogenic compositions") comprising (a) an anti-angiogenic factor and (b) a polymeric carrier. A wide variety of molecules may be utilized within the scope of the present invention as anti-angiogenic factors, including for example Anti-Invasive Factor, retinoic acids and their derivatives, taxol, taxol analogues and taxol derivatives, and members of the group consisting of Suramin, Tissue Inhibitor of Metalloproteinase-1, Tissue Inhibitor of Metalloproteinase-2, Plasminogen Activator Inhibitor-1 and Plasminogen Activator Inhibitor-2. Similarly, a wide variety of polymeric carriers may be utilized, representative examples of which include poly(ethylene-vinyl acetate) crosslinked with 40% vinyl acetate, poly (lactic-co-glycolic acid), polycaprolactone poly(lactic acid), copolymers of poly(ethylene-vinyl acetate) crosslinked with 40% vinyl acetate and poly(lactic acid), and copolymers of poly(lactic acid) and polycaprolactone. Within one embodiment of the invention, the composition has an average size of 15 to 200 μm .

Within another aspect of the present invention methods for embolizing a blood vessel are provided, comprising the step of delivering into the vessel a therapeutically effective amount of an anti-angiogenic composition

(as described above), such that the blood vessel is effectively occluded. Within one embodiment, the anti-angiogenic composition is delivered to a blood vessel which nourishes a tumor.

5 Within yet another aspect of the present invention, stents are provided comprising a generally tubular structure, the surface being coated with one or more anti-angiogenic compositions. Within other aspects of the present invention, methods are provided for expanding the lumen of a body passageway, comprising inserting a stent into the passageway, the stent having a generally tubular structure, the surface of the structure being coated with an anti-angiogenic composition as described above, such that the passageway is expanded. Within various embodiments of the invention, methods are provided for eliminating biliary obstructions, comprising inserting a biliary stent into a biliary passageway; for eliminating urethral obstructions, comprising inserting a urethral stent into a urethra; for eliminating esophageal obstructions, comprising inserting an esophageal stent into an esophagus; and for eliminating tracheal/bronchial obstructions, comprising inserting a tracheal/bronchial stent into the trachea or bronchi. In each of these embodiments, the stent has a generally tubular structure, the surface of which is coated with an anti-angiogenic composition as described above.

20 Within another aspect of the present invention, methods are provided for treating tumor excision sites, comprising administering an anti-angiogenic composition as described above to the resection margins of a tumor subsequent to excision, such that the local recurrence of cancer and the formation of new blood vessels at the site is inhibited. Within yet another aspect of the invention, methods for treating corneal neovascularization are provided, comprising the step of administering a therapeutically effective amount of an anti-angiogenic composition as described above to the cornea, such that the formation of blood vessels is inhibited. Within one embodiment, the anti-angiogenic composition further comprises a topical corticosteroid.

30 Within another aspect of the present invention, methods are provided for inhibiting angiogenesis in patients with non-tumorigenic, angiogenesis-dependent diseases, comprising administering a therapeutically effective amount of a composition comprising taxol to a patient with a non-tumorigenic angiogenesis-dependent disease, such that the formation of new blood vessels is inhibited. Within other aspects, methods are provided for embolizing blood vessels in non-tumorigenic, angiogenesis-dependent diseases,

35

comprising delivering to the vessel a therapeutically effective amount of a composition comprising taxol, such that the blood vessel is effectively occluded.

Within yet other aspects of the present invention, methods are provided for expanding the lumen of a body passageway, comprising inserting a
5 stent into the passageway, the stent having a generally tubular structure, the surface of the structure being coated with a composition comprising taxol, such that the passageway is expanded. Within various embodiments of the invention, methods are provided for eliminating biliary obstructions, comprising inserting a biliary stent into a biliary passageway; for eliminating urethral obstructions,
10 comprising inserting a urethral stent into a urethra; for eliminating esophageal obstructions, comprising inserting an esophageal stent into an esophagus; and for eliminating tracheal/bronchial obstructions, comprising inserting a tracheal/bronchial stent into the trachea or bronchi. Within each of these embodiments the stent has a generally tubular structure, the surface of the
15 structure being coated with a composition comprising taxol.

Within another aspect of the present invention, methods are provided for treating a tumor excision site, comprising administering a composition comprising taxol to the resection margin of a tumor subsequent to excision, such that the local recurrence of cancer and the formation of new
20 blood vessels at the site is inhibited. Within other aspects, methods are provided for treating corneal neovascularization, comprising administering a therapeutically effective amount of a composition comprising taxol to the cornea, such that the formation of new vessels is inhibited.

Within yet another aspect of the invention, pharmaceutical
25 products are provided, comprising (a) taxol, in a container, and (b) a notice associated with the container in form prescribed by a governmental agency regulating the manufacture, use, or sale of pharmaceuticals, which notice is reflective of approval by the agency of the taxol, for human or veterinary administration to treat non-tumorigenic angiogenesis-dependent diseases.
30 Briefly, Federal Law requires that the use of a pharmaceutical agent in the therapy of humans be approved by an agency of the Federal government. Responsibility for enforcement (in the United States) is with the Food and Drug Administration, which issues appropriate regulations for securing such approval, detailed in 21 U.S.C. §§ 301-392. Regulation for biological materials comprising
35 products made from the tissues of animals, is also provided under 42 U.S.C. § 262. Similar approval is required by most countries, although, regulations may vary from country to country.

These and other aspects of the present invention will become evident upon reference to the following detailed description and attached drawings. In addition, various references are set forth below which describe in more detail certain procedures or compositions, and are incorporated by
5 reference in their entirety.

Brief Description of the Drawings

Figure 1A is a photograph which shows a shell-less egg culture on day 6. Figure 1B is a digitized computer-displayed image taken with a stereomicroscope of living, unstained capillaries (1040x). Figure 1C is a corrosion casting which shows CAM microvasculature that are fed by larger, underlying vessels (arrows; 1300x). Figure 1D depicts a 0.5 mm thick plastic section cut transversely through the CAM, and recorded at the light microscope level. This photograph shows the composition of the CAM, including an outer
10 double-layered ectoderm (Ec), a mesoderm (M) containing capillaries (arrows) and scattered adventitial cells, and a single layered endoderm (En) (400x).
15 Figure 1E is a photograph at the electron microscope level (3500x) wherein typical capillary structure is presented showing thin-walled endothelial cells. (arrowheads) and an associated pericyte.

20 Figures 2A, 2B, 2C and 2D are a series of digitized images of four different, unstained CAMs taken after a 48 hour exposure to taxol.

Figures 3A, 3B and 3C are a series of photographs of 0.5 mm thick plastic sections transversely cut through a taxol-treated CAM at three different locations within the avascular zone.

25 Figures 4A, 4B and 4C are series of electron micrographs which were taken from locations similar to that of Figures 3A, 3B and 3C (respectively) above.

Figure 5 is a bar graph which depicts the size distribution of microspheres by number (5% ELVAX with 10 mg sodium suramin into 5%
30 PVA).

Figure 6 is a bar graph which depicts the size distribution of microspheres by weight (5% ELVAX with 10 mg sodium suramin into 5% PVA).

35 Figure 7 is a line graph which depicts the weight of encapsulation of Sodium Suramin in 1 ml of 5% ELVAX.

Figure 8 is a line graph which depicts the percent of encapsulation of Sodium Suramin in ELVAX.

Figure 9 is a bar graph which depicts the size distribution of 5% ELVAX microspheres containing 10 mg sodium suramin made in 5% PVA containing 10% NaCl.

Figure 10 is a bar graph which depicts the size distribution by weight of 5% PLL microspheres containing 10 mg sodium suramin made in 5% PVA containing 10% NaCl.

Figure 11 is a bar graph which depicts the size distribution by number of 5% PLL microspheres containing 10 mg sodium suramin made in 5% PVA containing 10% NaCl.

Figure 12 is a line graph which depicts the time course of sodium suramin release.

Figure 13 is an illustration of a representative embodiment of hepatic tumor embolization.

Figure 14 is an illustration of the insertion of a representative stent coated with an anti-angiogenic composition of the present invention.

Figure 15A is a graph which shows the effect of the EVA:PLA polymer blend ratio upon aggregation of microspheres. Figure 15B is a scanning electron micrograph which shows the size of "small" microspheres. Figure 15C is a scanning electron micrograph which shows the size of "large" microspheres. Figure 15D is a graph which depicts the time course of *in vitro* taxol release from 0.6% w/v taxol-loaded 50:50 EVA:PLA polymer blend microspheres into phosphate buffered saline (pH 7.4) at 37°C. Open circles are "small" sized microspheres, and closed circles are "large" sized microspheres. Figure 15E is a photograph of a CAM which shows the results of taxol release by microspheres ("MS"). Figure 15F is a photograph similar to that of 15E at increased magnification.

Figure 16 is a graph which shows release rate profiles from polycaprolactone microspheres containing 1%, 2%, 5% or 10% taxol into phosphate buffered saline at 37°C. Figure 16B is a photograph which shows a CAM treated with control microspheres. Figure 16C is a photograph which shows a CAM treated with 5% taxol loaded microspheres.

Figures 17A and 17B, respectively, are two graphs which show the release of taxol from EVA films, and the percent taxol remaining in those same films over time. Figure 17C is a graph which shows the swelling of EVA/F127 films with no taxol over time. Figure 17D is a graph which shows the swelling of EVA/Span 80 films with no taxol over time. Figure 17E is a graph which depicts a stress vs. strain curve for various EVA/F127 blends.

Figures 18A and 18B are two graphs which show the melting point of PCL/MePEG polymer blends as a function of % MePEG in the formulation (18A), and the percent increase in time needed for PCL paste at 60°C to begin to solidify as a function of the amount of MePEG in the formulation (18B).
5 Figure 18C is a graph which depicts the brittleness of varying PCL/MePEG polymer blends. Figure 18D is a graph which shows the percent weight change over time for polymer blends of various MePEG concentrations. Figure 18E is a graph which depicts the rate of taxol release over time from various polymer blends loaded with 1% taxol. Figures 18F and 18G are graphs which depict the
10 effect of varying quantities of taxol on the total amount of taxol released from a 20%MePEG/PCL blend. Figure 18H is a graph which depicts the effect of MePEG on the tensile strength of a MePEG/PCL polymer.

Figure 19A is a photograph which shows control (unloaded) thermopaste on a CAM. Figure 19B is a photograph of 20% taxol-loaded
15 thermopaste on a CAM.

Figures 20A and 20B are two photographs of a CAM having a tumor treated with control (unloaded) thermopaste. Figures 20C and 20D are two photographs of a CAM having a tumor treated with taxol-loaded thermopaste.

20 Figure 21A is a graph which shows the effect of taxol/PCL on tumor growth. Figures 21B and 21C are two photographs which show the effect of control, 10%, and 20% taxol-loaded thermopaste on tumor growth.

Figure 22A is a photograph of synovium from a PBS injected joint. Figure 22B is a photograph of synovium from a microsphere injected joint.
25 Figure 22C is a photograph of cartilage from joints injected with PBS, and Figure 22D is a photograph of cartilage from joints injected with microspheres.

Detailed Description of the Invention

30 As noted above, the present invention provides methods and compositions which utilize anti-angiogenic factors. Briefly, within the context of the present invention, anti-angiogenic factors should be understood to include any protein, peptide, chemical or other molecule which acts to inhibit vascular growth. A variety of methods may be readily utilized to determine the anti-
35 angiogenic activity of a given factor, including for example, chick chorioallantoic membrane ("CAM") assays. Briefly, as described in more detail below in Examples 2A and 2C, a portion of the shell from a freshly fertilized chicken egg

is removed, and a methyl cellulose disk containing a sample of the anti-angiogenic factor to be tested is placed on the membrane. After several days (e.g., 48 hours), inhibition of vascular growth by the sample to be tested may be readily determined by visualization of the chick chorioallantoic membrane in the region surrounding the methyl cellulose disk. Inhibition of vascular growth may also be determined quantitatively, for example, by determining the number and size of blood vessels surrounding the methyl cellulose disk, as compared to a control methyl cellulose disk. Particularly preferred anti-angiogenic factors suitable for use within the present invention completely inhibit the formation of new blood vessels in the assay described above.

A variety of assays may also be utilized to determine the efficacy of anti-angiogenic factors *in vivo*, including for example, mouse models which have been developed for this purpose (see Roberston et al., *Cancer. Res.* 51:1339-1344, 1991). In addition, a variety of representative *in vivo* assays relating to various aspects of the inventions described herein have been described in more detail below in Examples 5 to 7, and 17 to 19.

As noted above, the present invention provides compositions comprising an anti-angiogenic factor and a polymeric carrier. Briefly, a wide variety of anti-angiogenic factors may be readily utilized within the context of the present invention. Representative examples include Anti-Invasive Factor, retinoic acid and derivatives thereof, taxol, and members of the group consisting of Suramin, Tissue Inhibitor of Metalloproteinase-1, Tissue Inhibitor of Metalloproteinase-2, Plasminogen Activator Inhibitor-1 and Plasminogen Activator Inhibitor-2. These and other anti-angiogenic factors will be discussed in more detail below.

Briefly, Anti-Invasive Factor, or "AIF" which is prepared from extracts of cartilage, is known to contain constituents which are responsible for inhibiting the growth of new blood vessels. These constituents comprise a family of 7 low molecular weight proteins (<50,000 daltons) (Kuettner and Pauli, "Inhibition of neovascularization by a cartilage factor" in *Development of the Vascular System*, Pitman Books (Ciba Foundation Symposium 100), pp. 163-173, 1983), including a variety of proteins which have inhibitory effects against a variety of proteases (Eisentein et al, *Am. J. Pathol.* 81:337-346, 1975; Langer et al., *Science* 193:70-72, 1976; and Horton et al., *Science* 199:1342-1345, 1978). AIF suitable for use within the present invention may be readily prepared utilizing techniques known in the art (e.g., Eisentein et al, *supra*; Kuettner and Pauli, *supra*; and Langer et al., *supra*). Purified constituents of AIF such as

Cartilage-Derived Inhibitor ("CDI") (see Moses et al., *Science* 248:1408-1410, 1990) may also be readily prepared and utilized within the context of the present invention.

5 Retinoic acids alter the metabolism of extracellular matrix components, resulting in the inhibition of angiogenesis. Addition of proline analogs, angiostatic steroids, or heparin may be utilized in order to synergistically increase the anti-angiogenic effect of transretinoic acid. Retinoic acid, as well as derivatives thereof which may also be utilized in the context of the present invention, may be readily obtained from commercial sources, 10 including for example, Sigma Chemical Co. (# R2625).

Taxol is a highly derivatized diterpenoid (Wani et al., *J. Am. Chem. Soc.* 93:2325, 1971) which has been obtained from the harvested and dried bark of *Taxus brevifolia* (Pacific Yew.) and *Taxomyces Andreanae* and *Endophytic Fungus* of the Pacific Yew. (Stierle et al., *Science* 60:214-216, 1993). 15 Generally, taxol acts to stabilize microtubular structures by binding tubulin to form abnormal mitotic spindles. "Taxol" (which should be understood herein to include analogues and derivatives of taxol such as, for example, baccatin and taxotere) may be readily prepared utilizing techniques known to those skilled in the art (see also WO 94/07882, WO 94/07881, WO 94/07880, WO 94/07876, 20 WO 93/23555, WO 93/10076, U.S. Patent Nos. 5,294,637, 5,283,253, 5,279,949, 5,274,137, 5,202,448, 5,200,534, 5,229,526, and EP 590267) or obtained from a variety of commercial sources, including for example, Sigma Chemical Co., St. Louis, Missouri (T7402 - from *Taxus brevifolia*).

Suramin is a polysulfonated naphthylurea compound that is 25 typically used as a trypanocidal agent. Briefly, Suramin blocks the specific cell surface binding of various growth factors such as platelet derived growth factor ("PDGF"), epidermal growth factor ("EGF"), transforming growth factor ("TGF- β "), insulin-like growth factor ("IGF-1") and fibroblast growth factor (" β FGF"). Suramin may be prepared in accordance with known techniques, or readily 30 obtained from a variety of commercial sources, including for example Mobay Chemical Co., New York. (see Gagliardi et al., *Cancer Res.* 52:5073-5075, 1992; and Coffey, Jr., et al., *J. of Cell. Phys.* 132:143-148, 1987).

Tissue Inhibitor of Metalloproteinases-1 ("TIMP") is secreted by 35 endothelial cells which also secrete MTPases. TIMP is glycosylated and has a molecular weight of 28.5 kDa. TIMP-1 regulates angiogenesis by binding to activated metalloproteinases, thereby suppressing the invasion of blood vessels into the extracellular matrix. Tissue Inhibitor of Metalloproteinases-2 ("TIMP-

2") may also be utilized to inhibit angiogenesis. Briefly, TIMP-2 is a 21 kDa nonglycosylated protein which binds to metalloproteinases in both the active and latent, proenzyme forms. Both TIMP-1 and TIMP-2 may be obtained from commercial sources such as Synergen, Boulder, Colorado.

5 Plasminogen Activator Inhibitor - 1 (PAI-1) is a 50 kDa glycoprotein which is present in blood platelets, and can also be synthesized by endothelial cells and muscle cells. PAI-1 inhibits t-PA and urokinase plasminogen activator at the basolateral site of the endothelium, and additionally regulates the fibrinolysis process. Plasminogen Activator Inhibitor-2 (PAI-2) is generally
10 found only in the blood under certain circumstances such as in pregnancy, and in the presence of tumors. Briefly, PAI-2 is a 56 kDa protein which is secreted by monocytes and macrophages. It is believed to regulate fibrinolytic activity, and in particular inhibits urokinase plasminogen activator and tissue plasminogen activator, thereby preventing fibrinolysis.

15 A wide variety of other anti-angiogenic factors may also be utilized within the context of the present invention. Representative examples include Platelet Factor 4 (Sigma Chemical Co., #F1385); Protamine Sulphate (Clupeine) (Sigma Chemical Co., #P4505); Sulphated Chitin Derivatives (prepared from queen crab shells), (Sigma Chemical Co., #C3641; Murata
20 et al., *Cancer Res.* 51:22-26, 1991); Sulphated Polysaccharide Peptidoglycan Complex (SP-PG) (the function of this compound may be enhanced by the presence of steroids such as estrogen and tamoxifen citrate); Staurosporine (Sigma Chemical Co., #S4400); Modulators of Matrix Metabolism, including for example, proline analogs {[L-azetidine-2-carboxylic acid (LACA) (Sigma
25 Chemical Co., #A0760)), cishydroxyproline, d,L-3,4-dehydroproline (Sigma Chemical Co., #D0265), Thiaproline (Sigma Chemical Co., #T0631)], α,α -dipyridyl (Sigma Chemical Co., #D7505), β -aminopropionitrile fumarate (Sigma Chemical Co., #A3134)}}; MDL 27032 (4-propyl-5-(4-pyridinyl)-2(3H)-oxazolone; Merion Merrel Dow Research Institute); Methotrexate (Sigma
30 Chemical Co., #A6770; Hirata et al., *Arthritis and Rheumatism* 32:1065-1073, 1989); Mitoxantrone (Polverini and Novak, *Biochem. Biophys. Res. Comm.* 140:901-907); Heparin (Folkman, *Bio. Phar.* 34:905-909, 1985; Sigma Chemical Co., #P8754); Interferons (e.g., Sigma Chemical Co., #13265); 2 Macroglobulin-serum (Sigma Chemical Co., #M7151); ChIMP-3 (Pavloff et al., *J. Bio. Chem.*
35 267:17321-17326, 1992); Chymostatin (Sigma Chemical Co., #C7268; Tomkinson et al., *Biochem J.* 286:475-480, 1992); β -Cyclodextrin Tetradecasulfate (Sigma Chemical Co., #C4767); Eponemycin; Estramustine

(available from Sigma; Wang and Stearns *Cancer Res.* 48:6262-6271, 1988); Fumagillin (Sigma Chemical Co., #F6771; Canadian Patent No. 2,024,306; Ingber et al., *Nature* 348:555-557, 1990); Gold Sodium Thiomalate ("GST"; Sigma:G4022; Matsubara and Ziff, *J. Clin. Invest.* 79:1440-1446, 1987); (D-
5 Penicillamine ("CDPT"; Sigma Chemical Co., #P4875 or P5000(HCl)); β -1-
anticollagenase-serum; α 2-antiplasmin (Sigma Chem. Co.:A0914; Holmes et al.,
J. Biol. Chem. 262(4):1659-1664, 1987); Bisantrone (National Cancer Institute);
Lobenzarit disodium (N-(2)-carboxyphenyl-4-chloroanthronilic acid disodium or
"CCA"; Takeuchi et al., *Agents Actions* 36:312-316, 1992); Thalidomide,
10 Angiostatic steroid, AGM-1470, carboxyaminomidazole, metalloproteinase
inhibitors such as BB94 and the peptide CDPGYIGSR-NH₂ (SEQUENCE ID
NO. 1) (Iwaki Glass, Tokyo, Japan).

Anti-angiogenic compositions of the present invention may additionally comprise a wide variety of compounds in addition to the anti-
15 angiogenic factor and polymeric carrier. For example, anti-angiogenic
compositions of the present invention may also, within certain embodiments of
the invention, also comprise one or more antibiotics, anti-inflammatories, anti-
viral agents, anti-fungal agents and/or anti-protozoal agents. Representative
examples of antibiotics included within the compositions described herein
20 include: penicillins; cephalosporins such as cefadroxil, cefazolin, cefaclor;
aminoglycosides such as gentamycin and tobramycin; sulfonamides such as
sulfamethoxazole; and metronidazole. Representative examples of anti-
inflammatories include: steroids such as prednisone, prednisolone,
hydrocortisone, adrenocorticotrophic hormone, and sulfasalazine; and non-
25 steroidal anti-inflammatory drugs ("NSAIDS") such as aspirin, ibuprofen,
naproxen, fenopofen, indomethacin, and phenylbutazone. Representative
examples of antiviral agents include acyclovir, ganciclovir, zidovudine.
Representative examples of antifungal agents include: nystatin, ketoconazole,
griseofulvin, flucytosine, miconazole, clotrimazole. Representative examples of
30 antiprotozoal agents include: pentamidine isethionate, quinine, chloroquine,
and mefloquine.

Anti-angiogenic compositions of the present invention may also contain one or more hormones such as thyroid hormone, estrogen, progesterone, cortisone and/or growth hormone, other biologically active
35 molecules such as insulin, as well as T_H1 (e.g., Interleukins -2, -12, and -15,
gamma interferon or T_H2 (e.g., Interleukins -4 and -10) cytokines.

Anti-angiogenic compositions of the present invention may also comprise additional ingredients such as surfactants (either hydrophilic or hydrophobic; see Example 13), anti-neoplastic or chemotherapeutic agents (e.g., 5-fluorouracil, vinblastine, doxyrubicin, adriamycin, or tamocifen), radioactive agents (e.g., Cu-64, Ga-67, Ga-68, Zr-89, Ru-97, Tc-99m, Rh-105, Pd-109, In-111, I-123, I-125, I-131, Re-186, Re-188, Au-198, Au-199, Pb-203, At-211, Pb-212 and Bi-212) or toxins (e.g., ricin, abrin, diphtheria toxin, cholera toxin, gelonin, pokeweed antiviral protein, tritin, Shigella toxin, and Pseudomonas exotoxin A).

As noted above, anti-angiogenic compositions of the present invention comprise an anti-angiogenic factor and a polymeric carrier. In addition to the wide array of anti-angiogenic factors and other compounds discussed above, anti-angiogenic compositions of the present invention may include a wide variety of polymeric carriers, including for example both biodegradable and non-biodegradable compositions. Representative examples of biodegradable compositions include albumin, gelatin, starch, cellulose, destrans, polysaccharides, fibrinogen, poly (d,l lactide), poly (d,l-lactide-co-glycolide), poly (glycolide), poly (hydroxybutyrate), poly (alkylcarbonate) and poly (orthoesters) (see generally, Illum, L., Davids, S.S. (eds.) "Polymers in controlled Drug Delivery" Wright, Bristol, 1987; Arshady, *J. Controlled Release* 17:1-22, 1991; Pitt, *Int. J. Phar.* 59:173-196, 1990; Holland et al., *J. Controlled Release* 4:155-0180, 1986). Representative examples of nondegradable polymers include EVA copolymers, silicone rubber and poly (methylmethacrylate). Particularly preferred polymeric carriers include EVA copolymer (e.g., ELVAX 40, poly(ethylene-vinyl acetate) crosslinked with 40% vinyl acetate; DuPont), poly(lactic-co-glycolic acid), polycaprolactone, polylactic acid, copolymers of poly(ethylene-vinyl acetate) crosslinked with 40% vinyl acetate and polylactic acid, and copolymers of polylactic acid and polycaprolactone.

Polymeric carriers may be fashioned in a variety of forms, including for example, as nanospheres or microspheres, rod-shaped devices, pellets, slabs, or capsules (see, e.g., Goodell et al., *Am. J. Hosp. Pharm.* 43:1454-1461, 1986; Langer et al., "Controlled release of macromolecules from polymers", in *Biomedical polymers, Polymeric materials and pharmaceuticals for biomedical use*, Goldberg, E.P., Nakagim, A. (eds.) Academic Press, pp. 113-137, 1980; Rhine et al., *J. Pharm. Sci.* 69:265-270, 1980; Brown et al., *J. Pharm. Sci.* 72:1181-1185, 1983; and Bawa et al., *J. Controlled Release* 1:259-267, 1985).

Preferably, anti-angiogenic compositions of the present invention (which comprise one or more anti-angiogenic factors, and a polymeric carrier)

are fashioned in a manner appropriate to the intended use. Within preferred aspects of the present invention, the anti-angiogenic composition should be biocompatible, and release one or more anti-angiogenic factors over a period of several weeks to months. In addition, anti-angiogenic compositions of the present invention should preferably be stable for several months and capable of being produced and maintained under sterile conditions.

Within certain aspects of the present invention, anti-angiogenic compositions may be fashioned in any size ranging from nanospheres to microspheres (*e.g.*, from 0.1 μm to 500 μm), depending upon the particular use. For example, when used for the purpose of tumor embolization (as discussed below), it is generally preferable to fashion the anti-angiogenic composition in microspheres of between 15 and 500 μm , preferably between 15 and 200 μm , and most preferably, between 25 and 150 μm . Such nanoparticles may also be readily applied as a "spray", which solidifies into a film or coating. Nanoparticles (also termed "nanospheres") may be prepared in a wide array of sizes, including for example, from 0.1 μm to 3 μm , from 10 μm to 30 μm , and from 30 μm to 100 μm (see Example 8).

Anti-angiogenic compositions may also be prepared, given the disclosure provided herein, for a variety of other applications. For example, for the administration of anti-angiogenic compositions to the cornea, the compositions of the present invention may be incorporated into polymers as nanoparticles (see generally, Kreuter *J. Controlled Release* 16:169-176, 1991; Couvreur and Vauthier, *J. Controlled Release* 17:187-198, 1991). Such nanoparticles may also be readily applied as a "spray", which solidifies into a film or coating. Nanoparticles (also termed "nanospheres") may be prepared in a wide array of sizes, including for example, from 0.1 μm to 3 μm , from 10 μm to 30 μm , and from 30 μm to 100 μm (see Example 8).

Anti-angiogenic compositions of the present invention may also be prepared in a variety of "paste" or gel forms. For example, within one embodiment of the invention, anti-angiogenic compositions are provided which are liquid at one temperature (*e.g.*, temperature greater than 37°C, such as 40°C, 45°C, 50°C, 55°C or 60°C), and solid or semi-solid at another temperature (*e.g.*, ambient body temperature, or any temperature lower than 37°C). Such "thermopastes" may be readily made given the disclosure provided herein (*see, e.g.*, Examples 10 and 14).

Within yet other aspects of the invention, the anti-angiogenic compositions of the present invention may be formed as a film. Preferably, such

films are generally less than 5, 4, 3, 2, or 1, mm thick, more preferably less than 0.75 mm or 0.5 mm thick, and most preferably less than 500 μm to 100 μm thick. Such films are preferably flexible with a good tensile strength (e.g., greater than 50, preferably greater than 100, and more preferably greater than 150 or 200 N/cm²), good adhesive properties (i.e., readily adheres to moist or wet surfaces), and has controlled permeability. Representative examples of such films are set forth below in the Examples (see e.g., Example 13).

Representative examples of the incorporation of anti-angiogenic factors such as into a polymeric carriers are described in more detail below in Examples 3, 4 and 8-15.

ARTERIAL EMBOLIZATION

In addition to the compositions described above, the present invention also provides a variety of methods which utilize the above-described anti-angiogenic compositions. In particular, within one aspect of the present invention methods are provided for embolizing a blood vessel, comprising the step of delivering into the vessel a therapeutically effective amount of an anti-angiogenic composition (as described above), such that the blood vessel is effectively occluded. Therapeutically effective amounts suitable for occluding blood vessels may be readily determined given the disclosure provided below, and as described in Example 6. Within a particularly preferred embodiment, the anti-angiogenic composition is delivered to a blood vessel which nourishes a tumor (see Figure 13).

Briefly, there are a number of clinical situations (e.g., bleeding, tumor development) where it is desirable to reduce or abolish the blood supply to an organ or region. As described in greater detail below, this may be accomplished by injecting anti-angiogenic compositions of the present invention into a desired blood vessel through a selectively positioned catheter (see Figure 13). The composition travels via the blood stream until it becomes wedged in the vasculature, thereby physically (or chemically) occluding the blood vessel. The reduced or abolished blood flow to the selected area results in infarction (cell death due to an inadequate supply of oxygen and nutrients) or reduced blood loss from a damaged vessel.

For use in embolization therapy, anti-angiogenic compositions of the present invention are preferably non-toxic, thrombogenic, easy to inject down vascular catheters, radio-opaque, rapid and permanent in effect, sterile, and readily available in different shapes or sizes at the time of the procedure.

In addition, the compositions preferably result in the slow (ideally, over a period of several weeks to months) release of an anti-angiogenic factor. Particularly preferred anti-angiogenic compositions should have a predictable size of 15-200 μm after being injected into the vascular system. Preferably, they should not clump into larger particles either in solution or once injected. In addition, preferable compositions should not change shape or physical properties during storage prior to use.

Embolization therapy may be utilized in at least three principal ways to assist in the management of neoplasms: (1) definitive treatment of tumors (usually benign); (2) for preoperative embolization; and (3) for palliative embolization. Briefly, benign tumors may sometimes be successfully treated by embolization therapy alone. Examples of such tumors include simple tumors of vascular origin (*e.g.*, haemangiomas), endocrine tumors such as parathyroid adenomas, and benign bone tumors.

For other tumors, (*e.g.*, renal adenocarcinoma), preoperative embolization may be employed hours or days before surgical resection in order to reduce operative blood loss, shorten the duration of the operation, and reduce the risk of dissemination of viable malignant cells by surgical manipulation of the tumor. Many tumors may be successfully embolized preoperatively, including for example nasopharyngeal tumors, glomus jugular tumors, meningiomas, chemodectomas, and vagal neuromas.

Embolization may also be utilized as a primary mode of treatment for inoperable malignancies, in order to extend the survival time of patients with advanced disease. Embolization may produce a marked improvement in the quality of life of patients with malignant tumors by alleviating unpleasant symptoms such as bleeding, venous obstruction and tracheal compression. The greatest benefit from palliative tumor embolization, however, may be seen in patients suffering from the humoral effects of malignant endocrine tumors, wherein metastases from carcinoid tumors and other endocrine neoplasms such as insulinomas and glucagonomas may be slow growing, and yet cause great distress by virtue of the endocrine syndromes which they produce.

In general, embolization therapy utilizing anti-angiogenic compositions of the present invention is typically performed in a similar manner, regardless of the site. Briefly, angiography (a road map of the blood vessels) of the area to be embolized is first performed by injecting radiopaque contrast through a catheter inserted into an artery or vein (depending on the site to be embolized) as an X-ray is taken. The catheter may be inserted either

percutaneously or by surgery. The blood vessel is then embolized by refluxing anti-angiogenic compositions of the present invention through the catheter, until flow is observed to cease. Occlusion may be confirmed by repeating the angiogram.

5 Embolization therapy generally results in the distribution of compositions containing anti-angiogenic factors throughout the interstices of the tumor or vascular mass to be treated. The physical bulk of the embolic particles clogging the arterial lumen results in the occlusion of the blood supply. In addition to this effect, the presence of an anti-angiogenic factor(s) prevents the
10 formation of new blood vessels to supply the tumor or vascular mass, enhancing the devitalizing effect of cutting off the blood supply.

Therefore, it should be evident that a wide variety of tumors may be embolized utilizing the compositions of the present invention. Briefly, tumors are typically divided into two classes: benign and malignant. In a benign
15 tumor the cells retain their differentiated features and do not divide in a completely uncontrolled manner. In addition, the tumor is localized and nonmetastatic. In a malignant tumor, the cells become undifferentiated, do not respond to the body's growth and hormonal signals, and multiply in an uncontrolled manner; the tumor is invasive and capable of spreading to distant
20 sites (metastasizing).

Within one aspect of the present invention, metastases (secondary tumors) of the liver may be treated utilizing embolization therapy. Briefly, a catheter is inserted via the femoral or brachial artery and advanced into the hepatic artery by steering it through the arterial system under fluoroscopic
25 guidance. The catheter is advanced into the hepatic arterial tree as far as necessary to allow complete blockage of the blood vessels supplying the tumor(s), while sparing as many of the arterial branches supplying normal structures as possible. Ideally this will be a segmental branch of the hepatic artery, but it could be that the entire hepatic artery distal to the origin of the
30 gastroduodenal artery, or even multiple separate arteries, will need to be blocked depending on the extent of tumor and its individual blood supply. Once the desired catheter position is achieved, the artery is embolized by injecting anti-angiogenic compositions (as described above) through the arterial catheter until flow in the artery to be blocked ceases, preferably even after observation
35 for 5 minutes. Occlusion of the artery may be confirmed by injecting radiopaque contrast through the catheter and demonstrating by fluoroscopy or

X-ray film that the vessel which previously filled with contrast no longer does so. The same procedure may be repeated with each feeding artery to be occluded.

As noted above, both benign and malignant tumors may be embolized utilizing compositions of the present invention. Representative
5 examples of benign hepatic tumors include Hepatocellular Adenoma, Cavernous Haemangioma, and Focal Nodular Hyperplasia. Other benign tumors, which are more rare and often do not have clinical manifestations, may also be treated. These include Bile Duct Adenomas, Bile Duct Cystadenomas, Fibromas, Lipomas, Leiomyomas, Mesotheliomas, Teratomas, Myxomas, and
10 Nodular Regenerative Hyperplasia.

Malignant Hepatic Tumors are generally subdivided into two categories: primary and secondary. Primary tumors arise directly from the tissue in which they are found. Thus, a primary liver tumor is derived originally from the cells which make up the liver tissue (such as hepatocytes and biliary cells).
15 Representative examples of primary hepatic malignancies which may be treated by arterial embolization include Hepatocellularcarcinoma, Cholangiocarcinoma, Angiosarcoma, Cystadenocar-cinoma, Squamous Cell Carcinoma, and Hepatoblastoma.

A secondary tumor, or metastasis, is a tumor which originated
20 elsewhere in the body but has now spread to a distant organ. The common routes for metastasis are direct growth into adjacent structures, spread through the vascular or lymphatic systems, and tracking along tissue planes and body spaces (peritoneal fluid, cerebrospinal fluid, etc.). Secondary hepatic tumors are one of the most common causes of death in cancer patients and are by far
25 and away the most common form of liver tumor. Although virtually any malignancy can metastasize to the liver, tumors which are most likely to spread to the liver include: cancer of the stomach, colon, and pancreas; melanoma; tumors of the lung, oropharynx, and bladder; Hodgkin's and non-Hodgkin's lymphoma; tumors of the breast, ovary, and prostate. Each one of the above-
30 named primary tumors has numerous different tumor types which may be treated by arterial embolization (for example, there are over 32 different types of ovarian cancer).

As noted above, embolization therapy utilizing anti-angiogenic compositions of the present invention may also be applied to a variety of other
35 clinical situations where it is desired to occlude blood vessels. Within one aspect of the present invention, arteriovenous malformation may be treated by administration of one of the above-described compositions. Briefly,

arteriovenous malformations (vascular malformations) refers to a group of diseases wherein at least one (and most typically, many) abnormal communications between arteries and veins occur, resulting in a local tumor-like mass composed predominantly of blood vessels. Such disease may be either
5 congenital or acquired.

Within one embodiment of the invention, an arteriovenous malformation may be treated by inserting a catheter via the femoral or brachial artery, and advancing it into the feeding artery under fluoroscopic guidance. The catheter is preferably advanced as far as necessary to allow complete
10 blockage of the blood vessels supplying the vascular malformation, while sparing as many of the arterial branches supplying normal structures as possible (ideally this will be a single artery, but most often multiple separate arteries may need to be occluded, depending on the extent of the vascular malformation and its individual blood supply). Once the desired catheter position is achieved, each
15 artery may be embolized utilizing anti-angiogenic compositions of the present invention.

Within another aspect of the invention, embolization may be accomplished in order to treat conditions of excessive bleeding. For example, menorrhagia (excessive bleeding with menstruation) may be readily treated by
20 embolization of uterine arteries. Briefly, the uterine arteries are branches of the internal iliac arteries bilaterally. Within one embodiment of the invention, a catheter may be inserted via the femoral or brachial artery, and advanced into each uterine artery by steering it through the arterial system under fluoroscopic guidance. The catheter should be advanced as far as necessary to allow
25 complete blockage of the blood vessels to the uterus, while sparing as many arterial branches that arise from the uterine artery and supply normal structures as possible. Ideally a single uterine artery on each side may be embolized, but occasionally multiple separate arteries may need to be blocked depending on the individual blood supply. Once the desired catheter position is achieved,
30 each artery may be embolized by administration of the anti-angiogenic compositions as described above.

In a like manner, arterial embolization may be accomplished in a variety of other conditions, including for example for acute bleeding, vascular abnormalities, central nervous system disorders, and hypersplenism.

35

USE OF ANTI-ANGIOGENIC COMPOSITIONS AS COATINGS FOR STENTS

As noted above, the present invention also provides stents, comprising a generally tubular structure (which includes for example, spiral shapes), the surface of which is coated with a composition as described above.

5 Briefly, a stent is a scaffolding, usually cylindrical in shape, that may be inserted into a body passageway (e.g., bile ducts), which has been narrowed by a disease process (e.g., ingrowth by a tumor) in order to prevent closure or reclosure of the passageway. Stents act by physically holding open the walls of the body passage into which they are inserted.

10 A variety of stents may be utilized within the context of the present invention, including for example, esophageal stents, vascular stents, biliary stents, pancreatic stents, ureteric and urethral stents, lacrimal stents, eustachian tube stents, fallopian tube stents, and tracheal/bronchial stents.

Stents may be readily obtained from commercial sources, or
15 constructed in accordance with well known techniques. Representative examples of stents include those described in U.S. Patent No. 4,776,337, entitled "Expandable Intraluminal Graft, and Method and Apparatus for Implanting and Expandable Intraluminal Graft", U.S. Patent No. 5,176,626, entitled "Indwelling Stent", U.S. Patent No. 5,147,370 entitled "Nitinol Stent for Hollow Body
20 Conduits", U.S. Patent No. 5,064,435 entitled "Self-Expanding Prosthesis Having Stable Axial Length", U.S. Patent No. 5,052,998 entitled "Indwelling Stent and Method of Use", and U.S. Patent No. 5,041,126 entitled "Endovascular Stent and Delivery System, all of which are hereby incorporated by reference in their entirety.

25 Stents may be coated with anti-angiogenic compositions or anti-angiogenic factors of the present invention using a variety of methods, including for example: (a) by directly affixing to the stent an anti-angiogenic composition (e.g., by either spraying the stent with a polymer/drug film, or by dipping the stent into a polymer/drug solution), (b) by coating the stent with a substance
30 such as a hydrogel which will in turn absorb the anti-angiogenic composition (or anti-angiogenic factor above), (c) by interweaving anti-angiogenic composition coated thread (or the polymer itself formed into a thread) into the stent structure, (d) by inserting the stent into a sleeve or mesh which is comprised of or coated with an anti-angiogenic composition, or (e) constructing the stent
35 itself with an anti-angiogenic composition. Within preferred embodiments of the invention, the composition should firmly adhere to the stent during storage and at the time of insertion, and should not be dislodged from the stent when

the diameter is expanded from its collapsed size to its full expansion size. The anti-angiogenic composition should also preferably not degrade during storage, prior to insertion, or when warmed to body temperature after expansion inside the body. In addition, it should preferably coat the stent smoothly and evenly,
5 with a uniform distribution of angiogenesis inhibitor, while not changing the stent contour. Within preferred embodiments of the invention, the anti-angiogenic composition should provide a uniform, predictable, prolonged release of the anti-angiogenic factor into the tissue surrounding the stent once it has been deployed. For vascular stents, in addition to the above properties, the
10 composition should not render the stent thrombogenic (causing blood clots to form), or cause significant turbulence in blood flow (more than the stent itself would be expected to cause if it was uncoated).

Within another aspect of the present invention, methods are provided for expanding the lumen of a body passageway, comprising inserting a
15 stent into the passageway, the stent having a generally tubular structure, the surface of the structure being coated with an anti-angiogenic composition (or, an anti-angiogenic factor alone), such that the passageway is expanded. A variety of embodiments are described below wherein the lumen of a body passageway is expanded in order to eliminate a biliary, esophageal,
20 tracheal/bronchial, urethral or vascular obstruction. In addition, a representative example is described in more detail below in Example 7.

Generally, stents are inserted in a similar fashion regardless of the site or the disease being treated. Briefly, a preinsertion examination, usually a
25 diagnostic imaging procedure, endoscopy, or direct visualization at the time of surgery, is generally first performed in order to determine the appropriate positioning for stent insertion. A guidewire is then advanced through the lesion or proposed site of insertion, and over this is passed a delivery catheter which allows a stent in its collapsed form to be inserted. Typically, stents are capable
30 of being compressed, so that they can be inserted through tiny cavities via small catheters, and then expanded to a larger diameter once they are at the desired location. Once expanded, the stent physically forces the walls of the passageway apart and holds it open. As such, they are capable of insertion via a small opening, and yet are still able to hold open a large diameter cavity or passageway. The stent may be self-expanding (*e.g.*, the Wallstent and Gianturco
35 stents), balloon expandable (*e.g.*, the Palmaz stent and Strecker stent), or implanted by a change in temperature (*e.g.*, the Nitinol stent).

Stents are typically maneuvered into place under radiologic or direct visual control, taking particular care to place the stent precisely across the narrowing in the organ being treated. The delivery catheter is then removed, leaving the stent standing on its own as a scaffold. A post insertion examination, usually an x-ray, is often utilized to confirm appropriate positioning.

Within a preferred embodiment of the invention, methods are provided for eliminating biliary obstructions, comprising inserting a biliary stent into a biliary passageway, the stent having a generally tubular structure, the surface of the structure being coated with a composition as described above, such that the biliary obstruction is eliminated. Briefly, tumor overgrowth of the common bile duct results in progressive cholestatic jaundice which is incompatible with life. Generally, the biliary system which drains bile from the liver into the duodenum is most often obstructed by (1) a tumor composed of bile duct cells (cholangiocarcinoma), (2) a tumor which invades the bile duct (e.g., pancreatic carcinoma), or (3) a tumor which exerts extrinsic pressure and compresses the bile duct (e.g., enlarged lymph nodes).

Both primary biliary tumors, as well as other tumors which cause compression of the biliary tree may be treated utilizing the stents described herein. One example of primary biliary tumors are adenocarcinomas (which are also called Klatskin tumors when found at the bifurcation of the common hepatic duct). These tumors are also referred to as biliary carcinomas, choledocholangiocarcinomas, or adenocarcinomas of the biliary system. Benign tumors which affect the bile duct (e.g., adenoma of the biliary system), and, in rare cases, squamous cell carcinomas of the bile duct and adenocarcinomas of the gallbladder, may also cause compression of the biliary tree, and therefore, result in biliary obstruction.

Compression of the biliary tree is most commonly due to tumors of the liver and pancreas which compress and therefore obstruct the ducts. Most of the tumors from the pancreas arise from cells of the pancreatic ducts. This is a highly fatal form of cancer (5% of all cancer deaths; 26,000 new cases per year in the U.S.) with an average of 6 months survival and a 1 year survival rate of only 10%. When these tumors are located in the head of the pancreas they frequently cause biliary obstruction, and this detracts significantly from the quality of life of the patient. While all types of pancreatic tumors are generally referred to as "carcinoma of the pancreas," there are histologic subtypes including: adenocarcinoma, adenosquamous carcinoma, cystadeno-carcinoma, and acinar cell carcinoma. Hepatic tumors, as discussed above, may also cause

compression of the biliary tree, and therefore cause obstruction of the biliary ducts.

Within one embodiment of the invention, a biliary stent is first inserted into a biliary passageway in one of several ways: from the top end by inserting a needle through the abdominal wall and through the liver (a percutaneous transhepatic cholangiogram or "PTC"); from the bottom end by cannulating the bile duct through an endoscope inserted through the mouth, stomach, or duodenum (an endoscopic retrograde cholangiogram or "ERCP"); or by direct incision during a surgical procedure. A preinsertion examination, PTC, ERCP, or direct visualization at the time of surgery should generally be performed to determine the appropriate position for stent insertion. A guidewire is then advanced through the lesion, and over this a delivery catheter is passed to allow the stent to be inserted in its collapsed form. If the diagnostic exam was a PTC, the guidewire and delivery catheter will be inserted via the abdominal wall, while if the original exam was an ERCP the stent will be placed via the mouth. The stent is then positioned under radiologic, endoscopic, or direct visual control taking particular care to place it precisely across the narrowing in the bile duct. The delivery catheter will be removed leaving the stent standing as a scaffolding which holds the bile duct open. A further cholangiogram will be performed to document that the stent is appropriately positioned.

Within yet another embodiment of the invention, methods are provided for eliminating esophageal obstructions, comprising inserting an esophageal stent into an esophagus, the stent having a generally tubular structure, the surface of the structure being coated with an anti-angiogenic composition as described above, such that the esophageal obstruction is eliminated. Briefly, the esophagus is the hollow tube which transports food and liquids from the mouth to the stomach. Cancer of the esophagus or invasion by cancer arising in adjacent organs (*e.g.*, cancer of the stomach or lung) results in the inability to swallow food or saliva. Within this embodiment, a preinsertion examination, usually a barium swallow or endoscopy should generally be performed in order to determine the appropriate position for stent insertion. A catheter or endoscope may then be positioned through the mouth, and a guidewire is advanced through the blockage. A stent delivery catheter is passed over the guidewire under radiologic or endoscopic control, and a stent is placed precisely across the narrowing in the esophagus. A post insertion examination,

usually a barium swallow x-ray, may be utilized to confirm appropriate positioning.

5 Within other embodiments of the invention, methods are provided for eliminating tracheal/bronchial obstructions, comprising inserting a tracheal/bronchial stent into the trachea or bronchi, the stent having a generally tubular structure, the surface of which is coated with an anti-angiogenic composition as described above, such that the tracheal/bronchial obstruction is eliminated. Briefly, the trachea and bronchi are tubes which carry air from the mouth and nose to the lungs. Blockage of the trachea by cancer, invasion by cancer arising in adjacent organs (e.g., cancer of the lung), or collapse of the trachea or bronchi due to chondromalacia (weakening of the cartilage rings) results in inability to breathe. Within this embodiment of the invention, preinsertion examination, usually an endoscopy, should generally be performed in order to determine the appropriate position for stent insertion. A catheter or endoscope is then positioned through the mouth, and a guidewire advanced through the blockage. A delivery catheter is then passed over the guidewire in order to allow a collapsed stent to be inserted. The stent is placed under radiologic or endoscopic control in order to place it precisely across the narrowing. The delivery catheter may then be removed leaving the stent standing as a scaffold on its own. A post insertion examination, usually a bronchoscopy, may be utilized to confirm appropriate positioning.

10
15
20
25
30
35 Within another embodiment of the invention, methods are provided for eliminating urethral obstructions, comprising inserting a urethral stent into a urethra, the stent having a generally tubular structure, the surface of the structure being coated with an anti-angiogenic composition as described above, such that the urethral obstruction is eliminated. Briefly, the urethra is the tube which drains the bladder through the penis. Extrinsic narrowing of the urethra as it passes through the prostate, due to hypertrophy of the prostate, occurs in virtually every man over the age of 60 and causes progressive difficulty with urination. Within this embodiment, a preinsertion examination, usually an endoscopy or urethrogram should generally first be performed in order to determine the appropriate position for stent insertion, which is above the external urinary sphincter at the lower end, and close to flush with the bladder neck at the upper end. An endoscope or catheter is then positioned through the penile opening and a guidewire advanced into the bladder. A delivery catheter is then passed over the guidewire in order to allow stent insertion. The delivery catheter is then removed, and the stent expanded into place. A post insertion

examination, usually endoscopy or retrograde urethrogram, may be utilized to confirm appropriate position.

5 Within another embodiment of the invention, methods are provided for eliminating vascular obstructions, comprising inserting a vascular
10 stent into a blood vessel, the stent having a generally tubular structure, the surface of the structure being coated with an anti-angiogenic composition as described above, such that the vascular obstruction is eliminated. Briefly, stents may be placed in a wide array of blood vessels, both arteries and veins, to prevent recurrent stenosis at the site of failed angioplasties, to treat narrowings
15 that would likely fail if treated with angioplasty, and to treat post surgical narrowings (*e.g.*, dialysis graft stenosis). Representative examples of suitable sites include the iliac, renal, and coronary arteries, the superior vena cava, and in dialysis grafts. Within one embodiment, angiography is first performed in order to localize the site for placement of the stent. This is typically
20 accomplished by injecting radiopaque contrast through a catheter inserted into an artery or vein as an x-ray is taken. A catheter may then be inserted either percutaneously or by surgery into the femoral artery, brachial artery, femoral vein, or brachial vein, and advanced into the appropriate blood vessel by steering it through the vascular system under fluoroscopic guidance. A stent
25 may then be positioned across the vascular stenosis. A post insertion angiogram may also be utilized in order to confirm appropriate positioning.

USE OF ANTI-ANGIOGENIC COMPOSITIONS IN SURGICAL PROCEDURES

25 As noted above, anti-angiogenic compositions may be utilized in a wide variety of surgical procedures. For example, within one aspect of the present invention an anti-angiogenic compositions (in the form of, for example, a spray or film) may be utilized to coat or spray an area prior to removal of a tumor, in order to isolate normal surrounding tissues from malignant tissue, and/or to prevent the spread of disease to surrounding tissues. Within other
30 aspects of the present invention, anti-angiogenic compositions (*e.g.*, in the form of a spray) may be delivered via endoscopic procedures in order to coat tumors, or inhibit angiogenesis in a desired locale. Within yet other aspects of the present invention, surgical meshes which have been coated with anti-angiogenic compositions of the present invention may be utilized in any procedure wherein
35 a surgical mesh might be utilized. For example, within one embodiment of the invention a surgical mesh ladened with an anti-angiogenic composition may be utilized during abdominal cancer resection surgery (*e.g.*, subsequent to colon

resection) in order to provide support to the structure, and to release an amount of the anti-angiogenic factor.

5 Within further aspects of the present invention, methods are provided for treating tumor excision sites, comprising administering an anti-angiogenic composition as described above to the resection margins of a tumor subsequent to excision, such that the local recurrence of cancer and the formation of new blood vessels at the site is inhibited. Within one embodiment of the invention, the anti-angiogenic composition(s) (or anti-angiogenic factor(s) alone) are administered directly to the tumor excision site (*e.g.*, applied by 10 swabbing, brushing or otherwise coating the resection margins of the tumor with the anti-angiogenic composition(s) or factor(s)). Alternatively, the anti-angiogenic composition(s) or factor(s) may be incorporated into known surgical pastes prior to administration. Within particularly preferred embodiments of the invention, the anti-angiogenic compositions are applied after hepatic 15 resections for malignancy, and after neurosurgical operations.

 Within one aspect of the present invention, anti-angiogenic compositions (as described above) may be administered to the resection margin of a wide variety of tumors, including for example, breast, colon, brain and hepatic tumors. For example, within one embodiment of the invention anti-angiogenic compositions may be administered to the site of a neurological 20 tumor subsequent to excision, such that the formation of new blood vessels at the site are inhibited. Briefly, the brain is highly functionally localized; *i.e.*, each specific anatomical region is specialized to carry out a specific function. Therefore it is the location of brain pathology that is often more important than 25 the type. A relatively small lesion in a key area can be far more devastating than a much larger lesion in a less important area. Similarly, a lesion on the surface of the brain may be easy to resect surgically, while the same tumor located deep in the brain may not (one would have to cut through too many vital structures to reach it). Also, even benign tumors can be dangerous for several 30 reasons: they may grow in a key area and cause significant damage; even though they would be cured by surgical resection this may not be possible; and finally, if left unchecked they can cause increased intracranial pressure. The skull is an enclosed space incapable of expansion. Therefore, if something is growing in one location, something else must be being compressed in another 35 location - the result is increased pressure in the skull or increased intracranial pressure. If such a condition is left untreated, vital structures can be compressed, resulting in death. The incidence of CNS (central nervous system)

malignancies is 8-16 per 100,000. The prognosis of primary malignancy of the brain is dismal, with a median survival of less than one year, even following surgical resection. These tumors, especially gliomas, are predominantly a local disease which recur within 2 centimeters of the original focus of disease after
5 surgical removal.

Representative examples of brain tumors which may be treated utilizing the compositions and methods described herein include Glial Tumors (such as Anaplastic Astrocytoma, Glioblastoma Multiform, Pilocytic Astrocytoma, Oligodendroglioma, Ependymoma, Myxopapillary Ependymoma,
10 Subependymoma, Choroid Plexus Papilloma); Neuron Tumors (*e.g.*, Neuroblastoma, Ganglioneuroblastoma, Ganglioneuroma, and Medulloblastoma); Pineal Gland Tumors (*e.g.*, Pineoblastoma and Pineocytoma); Menigeal Tumors (*e.g.*, Meningioma, Meningeal Hemangiopericytoma, Meningeal Sarcoma); Tumors of Nerve Sheath Cells
15 (*e.g.*, Schwannoma (Neurolemmoma) and Neurofibroma); Lymphomas (*e.g.*, Hodgkin's and Non-Hodgkin's Lymphoma (including numerous subtypes, both primary and secondary); Malformative Tumors (*e.g.*, Craniopharyngioma, Epidermoid Cysts, Dermoid Cysts and Colloid Cysts); and Metastatic Tumors (which can be derived from virtually any tumor, the most common being from
20 lung, breast, melanoma, kidney, and gastrointestinal tract tumors).

OTHER THERAPEUTIC USES OF ANTI-ANGIOGENIC COMPOSITIONS

In addition to tumors, numerous other non-tumorigenic angiogenesis-dependent diseases which are characterized by the abnormal
25 growth of blood vessels may also be treated with the anti-angiogenic compositions, or anti-angiogenic factors of the present invention. Representative examples of such non-tumorigenic angiogenesis-dependent diseases include corneal neovascularization, hypertrophic scars and keloids, proliferative diabetic retinopathy, rheumatoid arthritis, arteriovenous
30 malformations (discussed above), atherosclerotic plaques, delayed wound healing, hemophilic joints, nonunion fractures, Osler-Weber syndrome, psoriasis, pyogenic granuloma, scleroderma, trachoma, menorrhagia (discussed above) and vascular adhesions.

In particular, within one aspect of the present invention methods
35 are provided for treating corneal neovascularization (including corneal graft neovascularization), comprising the step of administering a therapeutically effective amount of an anti-angiogenic composition (as described above) to the

cornea, such that the formation of blood vessels is inhibited. Briefly, the cornea is a tissue which normally lacks blood vessels. In certain pathological conditions, however, capillaries may extend into the cornea from the pericorneal vascular plexus of the limbus. When the cornea becomes vascularized, it also
5 becomes clouded, resulting in a decline in the patient's visual acuity. Visual loss may become complete if the cornea completely opacitates.

Blood vessels can enter the cornea in a variety of patterns and depths, depending upon the process which incites the neovascularization. These patterns have been traditionally defined by ophthalmologists in the following
10 types: pannus trachomatous, pannus leprosus, pannus phylctenulosus, pannus degenerativus, and glaucomatous pannus. The corneal stroma may also be invaded by branches of the anterior ciliary artery (called interstitial vascularization) which causes several distinct clinical lesions: terminal loops, a "brush-like" pattern, an umbel form, a lattice form, interstitial arcades (from
15 episcleral vessels), and aberrant irregular vessels.

A wide variety of disorders can result in corneal neovascularization, including for example corneal infections (*e.g.*, trachoma, herpes simplex keratitis, leishmaniasis and onchocerciasis), immunological processes (*e.g.*, graft rejection and Stevens-Johnson's syndrome), alkali burns,
20 trauma, inflammation (of any cause), toxic and nutritional deficiency states, and as a complication of wearing contact lenses.

While the cause of corneal neovascularization may vary, the response of the cornea to the insult and the subsequent vascular ingrowth is similar regardless of the cause. Briefly, the location of the injury appears to be
25 of importance as only those lesions situated within a critical distance of the limbus will incite an angiogenic response. This is likely due to the fact that the angiogenic factors responsible for eliciting the vascular invasion are created at the site of the lesion, and must diffuse to the site of the nearest blood vessels (the limbus) in order to exert their effect. Past a certain distance from the
30 limbus, this would no longer be possible and the limbic endothelium would not be induced to grow into the cornea. Several angiogenic factors are likely involved in this process, many of which are products of the inflammatory response. Indeed, neovascularization of the cornea appears to only occur in association with an inflammatory cell infiltrate, and the degree of angiogenesis
35 is proportional to the extent of the inflammatory reaction. Corneal edema further facilitates blood vessel ingrowth by loosening the corneal stromal

framework and providing a pathway of "least resistance" through which the capillaries can grow.

Following the initial inflammatory reaction, capillary growth into the cornea proceeds in the same manner as it occurs in other tissues. The normally quiescent endothelial cells of the limbic capillaries and venules are stimulated to divide and migrate. The endothelial cells project away from their vessels of origin, digest the surrounding basement membrane and the tissue through which they will travel, and migrate towards the source of the angiogenic stimulus. The blind ended sprouts acquire a lumen and then anastomose together to form capillary loops. The end result is the establishment of a vascular plexus within the corneal stroma.

Anti-angiogenic compositions of the present invention are useful by blocking the stimulatory effects of angiogenesis promoters, reducing endothelial cell division, decreasing endothelial cell migration, and impairing the activity of the proteolytic enzymes secreted by the endothelium.

Within particularly preferred embodiments of the invention, an anti-angiogenic factor may be prepared for topical administration in saline (combined with any of the preservatives and antimicrobial agents commonly used in ocular preparations), and administered in eyedrop form. The anti-angiogenic factor solution may be prepared in its pure form and administered several times daily. Alternatively, anti-angiogenic compositions, prepared as described above, may also be administered directly to the cornea. Within preferred embodiments, the anti-angiogenic composition is prepared with a muco-adhesive polymer which binds to cornea. Within further embodiments, the anti-angiogenic factors or anti-angiogenic compositions may be utilized as an adjunct to conventional steroid therapy.

Topical therapy may also be useful prophylactically in corneal lesions which are known to have a high probability of inducing an angiogenic response (such as chemical burns). In these instances the treatment, likely in combination with steroids, may be instituted immediately to help prevent subsequent complications.

Within other embodiments, the anti-angiogenic compositions described above may be injected directly into the corneal stroma by an ophthalmologist under microscopic guidance. The preferred site of injection may vary with the morphology of the individual lesion, but the goal of the administration would be to place the composition at the advancing front of the vasculature (*i.e.*, interspersed between the blood vessels and the normal cornea).

In most cases this would involve perilimbic corneal injection to "protect" the cornea from the advancing blood vessels. This method may also be utilized shortly after a corneal insult in order to prophylactically prevent corneal neovascularization. In this situation the material could be injected in the
5 perilimbic cornea interspersed between the corneal lesion and its undesired potential limbic blood supply. Such methods may also be utilized in a similar fashion to prevent capillary invasion of transplanted corneas. In a sustained-release form, injections might only be required 2-3 times per year. A steroid could also be added to the injection solution to reduce inflammation resulting
10 from the injection itself.

Within another aspect of the present invention, methods are provided for treating hypertrophic scars and keloids, comprising the step of administering one of the above-described anti-angiogenic compositions to a hypertrophic scar or keloid.

15 Briefly, healing of wounds and scar formation occurs in three phases: inflammation, proliferation, and maturation. The first phase, inflammation, occurs in response to an injury which is severe enough to break the skin. During this phase, which lasts 3 to 4 days, blood and tissue fluid form an adhesive coagulum and fibrinous network which serves to bind the wound
20 surfaces together. This is then followed by a proliferative phase in which there is ingrowth of capillaries and connective tissue from the wound edges, and closure of the skin defect. Finally, once capillary and fibroblastic proliferation has ceased, the maturation process begins wherein the scar contracts and becomes less cellular, less vascular, and appears flat and white. This final phase
25 may take between 6 and 12 months.

If too much connective tissue is produced and the wound remains persistently cellular, the scar may become red and raised. If the scar remains within the boundaries of the original wound it is referred to as a hypertrophic scar, but if it extends beyond the original scar and into the surrounding tissue,
30 the lesion is referred to as a keloid. Hypertrophic scars and keloids are produced during the second and third phases of scar formation. Several wounds are particularly prone to excessive endothelial and fibroblastic proliferation, including burns, open wounds, and infected wounds. With hypertrophic scars, some degree of maturation occurs and gradual improvement occurs. In the case
35 of keloids however, an actual tumor is produced which can become quite large. Spontaneous improvement in such cases rarely occurs.

Therefore, within one embodiment of the present invention either anti-angiogenic factors alone, or anti-angiogenic compositions as described above, are directly injected into a hypertrophic scar or keloid in order to prevent the progression of these lesions. The frequency of injections will depend upon the release kinetics of the polymer used (if present), and the clinical response. This therapy is of particular value in the prophylactic treatment of conditions which are known to result in the development of hypertrophic scars and keloids (e.g., burns), and is preferably initiated after the proliferative phase has had time to progress (approximately 14 days after the initial injury), but before hypertrophic scar or keloid development.

Within another aspect of the present invention methods are provided for treating neovascular glaucoma, comprising the step of administering a therapeutically effective amount of an anti-angiogenic composition to the eye, such that the formation of blood vessels is inhibited.

Briefly, neovascular glaucoma is a pathological condition wherein new capillaries develop in the iris of the eye. The angiogenesis usually originates from vessels located at the pupillary margin, and progresses across the root of the iris and into the trabecular meshwork. Fibroblasts and other connective tissue elements are associated with the capillary growth and a fibrovascular membrane develops which spreads across the anterior surface of the iris. Eventually this tissue reaches the anterior chamber angle where it forms synechiae. These synechiae in turn coalesce, scar, and contract to ultimately close off the anterior chamber angle. The scar formation prevents adequate drainage of aqueous humor through the angle and into the trabecular meshwork, resulting in an increase in intraocular pressure that may result in blindness.

Neovascular glaucoma generally occurs as a complication of diseases in which retinal ischemia is predominant. In particular, about one third of the patients with this disorder have diabetic retinopathy and 28% have central retinal vein occlusion. Other causes include chronic retinal detachment, end-stage glaucoma, carotid artery obstructive disease, retrolental fibroplasia, sickle-cell anemia, intraocular tumors, and carotid cavernous fistulas. In its early stages, neovascular glaucoma may be diagnosed by high magnification slitlamp biomicroscopy, where it reveals small, dilated, disorganized capillaries (which leak fluorescein) on the surface of the iris. Later gonioscopy demonstrates progressive obliteration of the anterior chamber angle by fibrovascular bands. While the anterior chamber angle is still open,

conservative therapies may be of assistance. However, once the angle closes surgical intervention is required in order to alleviate the pressure.

Therefore, within one embodiment of the invention anti-angiogenic factors (either alone or in an anti-angiogenic composition, as described above) may be administered topically to the eye in order to treat early forms of neovascular glaucoma.

Within other embodiments of the invention, anti-angiogenic compositions may be implanted by injection of the composition into the region of the anterior chamber angle. This provides a sustained localized increase of anti-angiogenic factor, and prevents blood vessel growth into the area. Implanted or injected anti-angiogenic compositions which are placed between the advancing capillaries of the iris and the anterior chamber angle can "defend" the open angle from neovascularization. As capillaries will not grow within a significant radius of the anti-angiogenic composition, patency of the angle could be maintained. Within other embodiments, the anti-angiogenic composition may also be placed in any location such that the anti-angiogenic factor is continuously released into the aqueous humor. This would increase the anti-angiogenic factor concentration within the humor, which in turn bathes the surface of the iris and its abnormal capillaries, thereby providing another mechanism by which to deliver the medication. These therapeutic modalities may also be useful prophylactically and in combination with existing treatments.

Within another aspect of the present invention, methods are provided for treating proliferative diabetic retinopathy, comprising the step of administering a therapeutically effective amount of an anti-angiogenic composition to the eyes, such that the formation of blood vessels is inhibited.

Briefly, the pathology of diabetic retinopathy is thought to be similar to that described above for neovascular glaucoma. In particular, background diabetic retinopathy is believed to convert to proliferative diabetic retinopathy under the influence of retinal hypoxia. Generally, neovascular tissue sprouts from the optic nerve (usually within 10 mm of the edge), and from the surface of the retina in regions where tissue perfusion is poor. Initially the capillaries grow between the inner limiting membrane of the retina and the posterior surface of the vitreous. Eventually, the vessels grow into the vitreous and through the inner limiting membrane. As the vitreous contracts, traction is applied to the vessels, often resulting in shearing of the vessels and blinding of the vitreous due to hemorrhage. Fibrous traction from scarring in the retina may also produce retinal detachment.

The conventional therapy of choice is panretinal photocoagulation to decrease retinal tissue, and thereby decrease retinal oxygen demands. Although initially effective, there is a high relapse rate with new lesions forming in other parts of the retina. Complications of this therapy include a decrease in
5 peripheral vision of up to 50% of patients, mechanical abrasions of the cornea, laser-induced cataract formation, acute glaucoma, and stimulation of subretinal neovascular growth (which can result in loss of vision). As a result, this procedure is performed only when several risk factors are present, and the risk-benefit ratio is clearly in favor of intervention.

10 Therefore, within particularly preferred embodiments of the invention, proliferative diabetic retinopathy may be treated by injection of an anti-angiogenic factor(s) (or anti-angiogenic composition) into the aqueous humor or the vitreous, in order to increase the local concentration of anti-angiogenic factor in the retina. Preferably, this treatment should be initiated
15 prior to the acquisition of severe disease requiring photocoagulation. Within other embodiments of the invention, arteries which feed the neovascular lesions may be embolized (utilizing anti-angiogenic compositions, as described above)

Within another aspect of the present invention, methods are provided for treating retrolental fibroblasia, comprising the step of
20 administering a therapeutically effective amount of an anti-angiogenic factor (or anti-angiogenic composition) to the eye, such that the formation of blood vessels is inhibited.

Briefly, retrolental fibroblasia is a condition occurring in premature infants who receive oxygen therapy. The peripheral retinal
25 vasculature, particularly on the temporal side, does not become fully formed until the end of fetal life. Excessive oxygen (even levels which would be physiologic at term) and the formation of oxygen free radicals are thought to be important by causing damage to the blood vessels of the immature retina. These vessels constrict, and then become structurally obliterated on exposure to
30 oxygen. As a result, the peripheral retina fails to vascularize and retinal ischemia ensues. In response to the ischemia, neovascularization is induced at the junction of the normal and the ischemic retina.

In 75% of the cases these vessels regress spontaneously. However, in the remaining 25% there is continued capillary growth, contraction
35 of the fibrovascular component, and traction on both the vessels and the retina. This results in vitreous hemorrhage and/or retinal detachment which can lead

to blindness. Neovascular angle-closure glaucoma is also a complication of this condition.

As it is often impossible to determine which cases will spontaneously resolve and which will progress in severity, conventional treatment (*i.e.*, surgery) is generally initiated only in patients with established disease and a well developed pathology. This "wait and see" approach precludes early intervention, and allows the progression of disease in the 25% who follow a complicated course. Therefore, within one embodiment of the invention, topical administration of anti-angiogenic factors (or anti-angiogenic compositions, as described above) may be accomplished in infants which are at high risk for developing this condition in an attempt to cut down on the incidence of progression of retrolental fibroplasia. Within other embodiments, intravitreal injections and/or intraocular implants of an anti-angiogenic composition may be utilized. Such methods are particularly preferred in cases of established disease, in order to reduce the need for surgery.

Within another aspect of the present invention, methods are provided for treating rheumatoid arthritis, comprising the step of administering a therapeutically effective amount of an anti-angiogenic composition to a joint, such that the formation of blood vessels is inhibited.

Briefly, in rheumatoid arthritis articular damage is due to a combination of inflammation (including white blood cells and white blood cell products) and pannus tissue development (a tissue composed of neovascular tissue, connective tissue, and inflammatory cells). Generally, chronic inflammation in itself is insufficient to result in damage to the joint surface, but a permanent deficit is created once fibrovascular tissue digests the cartilage tissue.

Within a preferred embodiment of the invention, anti-angiogenic factors (including anti-angiogenic compositions, as described above) may be administered by intra-articular injection, as a surgical paste, or as an oral agent (*e.g.*, containing the anti-angiogenic factor thalidomide), in order to inhibit the formation of blood vessels within the joint. One representative example of such a method is set forth in more detail below in Example 19.

As noted above, within yet another aspect of the present invention, vascular grafts are provided comprising a synthetic tube, the surface of which is coated with an anti-angiogenic composition as described above. Briefly, vascular grafts are synthetic tubes, usually made of Dacron or Gortex, inserted surgically to bypass arterial blockages, most frequently from the aorta

to the femoral, or the femoral to the popliteal artery. A major problem which particularly complicates femoral-popliteal bypass grafts is the formation of a subendothelial scar-like reaction in the blood vessel wall called neointimal hyperplasia, which narrows the lumen within and adjacent to either end of the graft, and which can be progressive. A graft coated with or containing anti-angiogenic factors (or anti-angiogenic compositions, as described above) may be utilized to limit the formation of neointimal hyperplasia at either end of the graft. The graft may then be surgically placed by conventional bypass techniques.

Anti-angiogenic compositions of the present invention may also be utilized in a variety of other manners. For example, they may be incorporated into surgical sutures in order to prevent stitch granulomas, implanted in the uterus (in the same manner as an IUD) for the treatment of menorrhagia or as a form of female birth control, administered as either a peritoneal lavage fluid or for peritoneal implantation in the treatment of endometriosis, attached to a monoclonal antibody directed against activated endothelial cells as a form of systemic chemotherapy, or utilized in diagnostic imaging when attached to a radioactively labelled monoclonal antibody which recognizes activated endothelial cells.

20

The following examples are offered by way of illustration, and not by way of limitation.

EXAMPLES

EXAMPLE 1

PREPARATION OF ANTI-INVASIVE FACTOR

5

The shoulder girdle and skull from a dogfish is excised, then scraped with a scalpel in order to remove all muscle and associated connective tissue from the cartilage. The cartilage is then homogenized with a tissue grinder, and extracted by continuous stirring at room temperature for 2 to 5 days in a solution containing 2.0 M guanidium hydrochloride and 0.02 M MES at pH 6.0.

After 2 to 5 days, the cartilage extract is passed through gauze netting in order to remove the larger constituents. The filtrate is then passed through an Amicon ultrafiltration unit which utilizes spiral-wound cartridges, with a molecular weight cutoff of 100,000. The filtrate (containing proteins with a molecular weight of less than 100,000 daltons) is then dialyzed against 0.02 M MES buffer (pH 6) with an Amicon ultrafiltration unit which retains proteins with a molecular weight of greater than 3,000 daltons. Utilizing this method, low molecular weight proteins and constituents are removed, as well as excessive amounts of guanidium HCl. The dialysate is concentrated to a final concentration 9 mg/ml.

EXAMPLE 2

25

ANALYSIS OF VARIOUS AGENTS FOR ANTI-ANGIOGENIC ACTIVITY

A. Chick Chorioallantoic Membrane ("Cam") Assays

Fertilized, domestic chick embryos were incubated for 3 days prior to shell-less culturing. In this procedure, the egg contents were emptied by removing the shell located around the air space. The interior shell membrane was then severed and the opposite end of the shell was perforated to allow the contents of the egg to gently slide out from the blunted end. The egg contents were emptied into round-bottom sterilized glass bowls and covered with petri dish covers. These were then placed into an incubator at 90% relative humidity and 3% CO₂ and incubated for 3 days.

Taxol (Sigma, St. Louis, MI) was mixed at concentrations of 1, 5, 10, 30mg per 10ml aliquot of 0.5% aqueous methylcellulose. Since taxol is insoluble in water, glass beads were used to produce fine particles. Ten microliter aliquots of this solution were dried on parafilm for 1 hour forming
5 disks 2mm in diameter. The dried disks containing taxol were then carefully placed at the growing edge of each CAM at day 6 of incubation. Controls were obtained by placing taxol-free methylcellulose disks on the CAMs over the same time course. After a 2 day exposure (day 8 of incubation) the vasculature was examined with the aid of a stereomicroscope. Liposyn II, a white opaque
10 solution, was injected into the CAM to increase the visibility of the vascular details. The vasculature of unstained, living embryos were imaged using a Zeiss stereomicroscope which was interfaced with a video camera (Dage-MTI Inc., Michigan City, IN). These video signals were then displayed at 160 times magnification and captured using an image analysis system (Vidas, Kontron;
15 Etching, Germany). Image negatives were then made on a graphics recorder (Model 3000; Matrix Instruments, Orangeburg, NY).

The membranes of the 8 day-old shell-less embryo were flooded with 2% glutaraldehyde in 0.1M Na cacodylate buffer; additional fixative was injected under the CAM. After 10 minutes *in situ*, the CAM was removed and
20 placed into fresh fixative for 2 hours at room temperature. The tissue was then washed overnight in cacodylate buffer containing 6% sucrose. The areas of interest were postfixed in 1% osmium tetroxide for 1.5 hours at 4°C. The tissues were then dehydrated in a graded series of ethanols, solvent exchanged with propylene oxide, and embedded in Spurr resin. Thin sections were cut with
25 a diamond knife, placed on copper grids, stained, and examined in a Joel 1200EX electron microscope. Similarly, 0.5 mm sections were cut and stained with toluene blue for light microscopy.

At day 11 of development, chick embryos were used for the corrosion casting technique. Mercox resin (Ted Pella, Inc., Redding, CA) was
30 injected into the CAM vasculature using a 30-gauge hypodermic needle. The casting material consisted of 2.5 grams of Mercox CL-2B polymer and 0.05 grams of catalyst (55% benzoyl peroxide) having a 5 minute polymerization time. After injection, the plastic was allowed to sit *in situ* for an hour at room temperature and then overnight in an oven at 65°C. The CAM was then placed
35 in 50% aqueous solution of sodium hydroxide to digest all organic components. The plastic casts were washed extensively in distilled water, air-dried, coated

with gold/palladium, and viewed with the Philips 501B scanning electron microscope.

Results of the above experiments are shown in Figures 1-4. Briefly, the general features of the normal chick shell-less egg culture are shown in Figure 1A. At day 6 of incubation, the embryo is centrally positioned to a radially expanding network of blood vessels; the CAM develops adjacent to the embryo. These growing vessels lie close to the surface and are readily visible making this system an idealized model for the study of angiogenesis. Living, unstained capillary networks of the CAM can be imaged noninvasively with a stereomicroscope. Figure 1B illustrates such a vascular area in which the cellular blood elements within capillaries were recorded with the use of a video/computer interface. The 3-dimensional architecture of such CAM capillary networks is shown by the corrosion casting method and viewed in the scanning electron microscope (Figure 1C). These castings revealed underlying vessels which project toward the CAM surface where they form a single layer of anastomotic capillaries.

Transverse sections through the CAM show an outer ectoderm consisting of a double cell layer, a broader mesodermal layer containing capillaries which lie subjacent to the ectoderm, adventitial cells, and an inner, single endodermal cell layer (Figure 1D). At the electron microscopic level, the typical structural details of the CAM capillaries are demonstrated. Typically, these vessels lie in close association with the inner cell layer of ectoderm (Figure 1E)

After 48 hours exposure to taxol at concentrations of 1, 5, 10, or 30 mg, each CAM was examined under living conditions with a stereomicroscope equipped with a video/computer interface in order to evaluate the effects on angiogenesis. This imaging setup was used at a magnification of 160 times which permitted the direct visualization of blood cells within the capillaries; thereby blood flow in areas of interest could be easily assessed and recorded. For this study, the inhibition of angiogenesis was defined as an area of the CAM devoid of a capillary network ranging from 2 - 6 mm in diameter. Areas of inhibition lacked vascular blood flow and thus were only observed under experimental conditions of methylcellulose containing taxol; under control conditions of disks lacking taxol there was no effect on the developing capillary system. The dose-dependent, experimental data of the effects of taxol at different concentrations are shown in Table II.

TABLE II

<u>Angiogenic Inhibition by Taxol</u>		
Taxol Concentration μg	Embryos Evaluated (Positive/Total)	% Inhibition
30	31/31	100
10	16/21	76
5	18/25	72
1	6/15	40
Control	0/30	0

Typical taxol-treated CAMs (Figures 2A and 2B) are shown with the transparent methylcellulose disk centrally positioned over the avascular zone measuring 6 mm in diameter. At a slightly higher magnification, the periphery of such avascular zones is clearly evident (Figure 2C); the surrounding functional vessels were often redirected away from the source of taxol (Figures 2C and 2D). Such angular redirecting of blood flow was never observed under normal conditions. Another feature of the effects of taxol was the formation of blood islands within the avascular zone representing the aggregation of blood cells.

The associated morphological alterations of the taxol-treated CAM are readily apparent at both the light and electron microscopic levels. For the convenience of presentation, three distinct phases of general transition from the normal to the avascular state are shown. Near the periphery of the avascular zone the CAM is hallmarked by an abundance of mitotic cells within all three germ layers (Figures 3A and 4A). This enhanced mitotic division was also a consistent observation for capillary endothelial cells. However, the endothelial cells remained junctionally intact with no extravasation of blood cells. With further degradation, the CAM is characterized by the breakdown and dissolution of capillaries (Figures 3B and 4B). The presumptive endothelial cells, typically arrested in mitosis, still maintain a close spatial relationship with blood cells and lie subjacent to the ectoderm; however, these cells are not junctionally linked. The most central portion of the avascular zone was characterized by a thickened ectodermal and endodermal layer (Figures 3C and 4C). Although these layers were thickened, the cellular junctions remained

intact and the layers maintained their structural characteristics. Within the mesoderm, scattered mitotically arrested cells were abundant; these cells did not exhibit the endothelial cell polarization observed in the former phase. Also, throughout this avascular region, degenerating cells were common as noted by
5 the electron dense vacuoles and cellular debris (Figure 4C).

In summary, this study demonstrated that 48 hours after taxol application to the CAM, angiogenesis was inhibited. The blood vessel inhibition formed an avascular zone which was represented by three transitional phases of
10 taxol's effect. The central, most affected area of the avascular zone contained disrupted capillaries with extravasated red blood cells; this indicated that intercellular junctions between endothelial cells were absent. The cells of the endoderm and ectoderm maintained their intercellular junctions and therefore these germ layers remained intact; however, they were slightly thickened. As
15 the normal vascular area was approached, the blood vessels retained their junctional complexes and therefore also remained intact. At the periphery of the taxol-treated zone, further blood vessel growth was inhibited which was evident by the typical redirecting or "elbowing" effect of the blood vessels (Figure 24D).

20 Taxol-treated avascular zones also revealed an abundance of cells arrested in mitosis in all three germ layers of the CAM; this was unique to taxol since no previous study has illustrated such an event. By being arrested in mitosis, endothelial cells could not undergo their normal metabolic functions involved in angiogenesis. In comparison, the avascular zone formed by suramin
25 and cortisone acetate do not produce mitotically arrested cells in the CAM; they only prevented further blood vessel growth into the treated area. Therefore, even though agents are anti-angiogenic, there are many points in which the angiogenesis process may be targeted.

We also observed the effects of taxol over the 48 hour duration
30 and noticed that inhibition of angiogenesis occurs as early as 9 hours after application. Histological sections revealed a similar morphology as seen in the first transition phase of the avascular zone at 48 hours illustrated in figure 3a and 4a. Also, we observed the revascularization process into the avascular zone previously observed. It has been found that the avascular zone formed by
35 heparin and angiostatic steroids became revascularized 60 hours after application. In our study, taxol-treated avascular zones did not revascularize for at least 7 days after application implying a more potent long-term effect.

EXAMPLE 3

ENCAPSULATION OF SURAMIN

5

One milliliter of 5% ELVAX (poly(ethylene-vinyl acetate) cross-linked with 5% vinyl acetate) in dichloromethane ("DCM") is mixed with a fixed weight of sub-micron ground sodium suramin. This mixture is injected into 5 ml of 5% Polyvinyl Alcohol ("PVA") in water in a 30 ml flat bottomed test tube. Tubes containing different weights of the drug are then suspended in a multi-sample water bath at 40° for 90 minutes with automated stirring. The mixes are removed, and microsphere samples taken for size analysis. Tubes are centrifuged at 1000g for 5 min. The PVA supernatant is removed and saved for analysis (nonencapsulated drug). The microspheres are then washed (vortexed) in 5 ml of water and recentrifuged. The 5 ml wash is saved for analysis (surface bound drug). Microspheres are then wetted in 50 ul of methanol, and vortexed in 1 ml of DCM to dissolve the ELVAX. The microspheres are then warmed to 40°C, and 5 ml of 50°C water is slowly added with stirring. This procedure results in the immediate evaporation of DCM, thereby causing the release of sodium suramin into the 5 ml of water. All three 5 ml samples were then assayed for drug content.

Sodium suramin absorbs uv/vis with a lambda max of 312nm. The absorption is linear in the 0 to 100 ug/ml range in both water and 5% PVA. The drug fluoresces strongly with an excitation maximum at 312nm, and emission maximum at 400nm. This fluorescence is quantifiable in the 0 to 25 ug/ml range.

Results are shown in Figures 5-10. Briefly, the size distribution of microspheres appears to be unaffected by inclusion of the drug in the DCM (see Figures 5 and 6). Good yields of microspheres in the 20 to 60 μ m range may be obtained.

The encapsulation of suramin is very low (<1%) (see Figure 8). However as the weight of drug is increased in the DCM the total amount of drug encapsulated increased although the % encapsulation decreased. As is shown in Figure 7, 50ug of drug may be encapsulated in 50 mg of ELVAX. Encapsulation of sodium suramin in 5% PVA containing 10% NaCl is shown in Figures 9-10.

EXAMPLE 4

ENCAPSULATION OF TAXOL

5 Five hundred micrograms of either taxol or baccatin (a taxol analog, available from Inflazyme Pharmaceuticals Inc., Vancouver, British Columbia, Canada) are dissolved in 1 ml of a 50:50 ELVAX:poly-l-lactic acid mixture in dcm. Microspheres are then prepared in a dissolution machine (Six-spindle dissolution tester, VanderKanp, Van Kell Industries Inc., U.S.A.) in
10 triplicate at 200 rpm, 42°C, for 3 hours. Microspheres so prepared are washed twice in water and sized on the microscope.

Determination of taxol encapsulation is undertaken in a uv/vis assay (uv/vis lamda max. at 237 nm, fluorescence assay at excitation 237, emission at 325 nm; Fluorescence results are presented in square brackets []).
15 Utilizing the procedures described above, 58 μg (+/-12 μg) [75 μg (+/-25 μg)] of taxol may be encapsulated from a total 500 μg of starting material. This represents 12% (+/-2.4%) [15% (+/-5%)] of the original weight, or 1.2% (+/-0.25%) [1.5% (+/-0.5%)] by weight of the polymer. After 18 hours of tumbling in an oven at 37°C, 10.3% (+/-10%) [6% (+/-5.6%)] of the total taxol had been
20 released from the microspheres.

For baccatin, 100 +/-15 μg [83 +/-23 μg] of baccatin can be encapsulated from a total of 500 μg starting material. This represents a 20% (+/-3%) [17% (+/-5%)] of the original weight of baccatin, and 2% (+/-0.3%) [1.7% (+/-0.5%)] by weight of the polymer. After 18 hours of tumbling in an
25 oven at 37°C, 55% (+/-13%) [60% (+/- 23%)] of the baccatin is released from the microspheres.

EXAMPLE 5ANALYSIS OF SURGICAL PASTE CONTAINING
ANTI-ANGIOGENIC COMPOSITIONS

30 Fisher rats weighing approximately 300 grams are anesthetized, and a 1 cm transverse upper abdominal incision is made. Two-tenths of a
35 milliliter of saline containing 1×10^6 live 9L gliosarcoma cells (eluted immediately prior to use from tissue culture) are injected into 2 of the 5 hepatic lobes by piercing a 27 gauge needle 1 cm through the liver capsule. The

abdominal wound is closed with 6.0 resorbable suture and skin clips and the GA terminated.

After 2 weeks, the tumor deposits will measure approximately 1 cm. At this time, both hepatic tumors are resected and the bare margin of the liver is packed with a hemostatic agent. The rats are divided into two groups: half is administered polymeric carrier alone, and the other half receives an anti-angiogenic composition.

Rats are sacrificed 2, 7, 14, 21 and 84 days post hepatic resection. In particular, the rats are euthanized by injecting Euthanyl into the dorsal vein of the tail. The liver, spleen, and both lungs are removed, and histologic analysis is performed in order to study the tumors for evidence of anti-angiogenic activity.

15

EXAMPLE 6

EMBOLIZATION OF RAT ARTERIES

Fisher rats weighing approximately 300 grams are anesthetized. Utilizing aseptic procedures, a 1 cm transverse upper abdominal incision is made, and the liver identified. Two-tenths of a milliliter of saline containing 1 million live 9L gliosarcoma cells (eluted immediately prior from tissue culture) is injected into each of the 5 hepatic lobes by piercing a 27 gauge needle 1 cm through the liver capsule. One-tenth of a milliliter of normal saline is injected into the needle as it is withdrawn to ensure that there is no spillage of cells into the peritoneal cavity. A pledget of gelfoam is placed on each of the puncture sites to ensure hemostasis. The abdominal wound is closed with 6.0 resorbable suture with skin clips, and the anesthetic terminated. The rat is returned to the animal care facility to have a standard diet for 14 days, at which time each tumor deposit will measure 1 cm in diameter. The same procedure is repeated using Westar rats and a Colon Cancer cell line (Radiologic Oncology Lab, M.D. Anderson, Houston, Texas). In this instance, 3 weeks are required post-injection for the tumor deposits to measure 1 cm in diameter each.

After 2 or 3 weeks, depending on the rat species, the same general anesthetic procedure is followed and a midline abdominal incision is performed. The duodenum is flipped and the gastroduodenal artery is identified and mobilized. Ties are placed above and below a cutdown site on the midportion of the gastroduodenal artery (GDA), and 0.038 inch polyethylene tubing is

introduced in a retrograde fashion into the artery using an operating microscope. The tie below the insertion point will ligate the artery, while the one above will fix the catheter in place. Angiography is performed by injecting 0.5 ml of 60% radiopaque contrast material through the catheter as an x-ray is taken. The hepatic artery is then embolized by refluxing particles measuring 15-200 μm through the gastroduodenal artery catheter until flow, observed via the operating microscope, is seen to cease for at least 30 seconds. Occlusion of the hepatic artery is confirmed by repeating an angiogram through the GDA catheter. Utilizing this procedure, one-half of the rats receive 15-200 μm particles of polymer alone, and the other half receive 15-200 μm particles of the polymer-anti-angiogenic factor composition. The upper GDA ligature is tightened to occlude the GDA as the catheter is withdrawn to ensure hemostasis, and the hepatic artery (although embolized) is left intact. The abdomen is closed with 6.0 absorbable suture and surgical clips.

The rats are subsequently sacrificed at 2, 7, 14, 21 and 84 days post-embolization in order to determine efficacy of the anti-angiogenic factor. Briefly, general anesthetic is given, and utilizing aseptic precautions, a midline incision performed. The GDA is mobilized again, and after placing a ligature near the junction of the GDA and the hepatic artery (*i.e.*, well above the site of the previous cutdown), a 0.038-inch polyethylene tubing is inserted via cutdown of the vessel and angiography is performed. The rat is then euthanized by injecting Euthanyl into the dorsal vein of the tail. Once euthanasia is confirmed, the liver is removed *en bloc* along with the stomach, spleen and both lungs.

Histologic analysis is performed on a prepared slide stained with hematoxylin and eosin ("H and E") stain. Briefly, the lungs are sectioned at 1 cm intervals to assess passage of embolic material through the hepatic veins and into the right side of circulation. The stomach and spleen are also sectioned in order to assess inadvertent immobilization from reflux of particles into the celiac access of the collateral circulation.

EXAMPLE 7

TRANSPLANTATION OF BILIARY STENTS IN RATS

General anesthetic is administered to 300 gram Fisher rats. A 1 cm transverse incision is then made in the upper abdomen, and the liver identified. In the most superficial lobe, 0.2 ml of saline containing 1 million

cells of 9L gliosarcoma cells (eluted from tissue culture immediately prior to use) is injected via a 27 gauge needle to a depth of 1 cm into the liver capsule. Hemostasis is achieved after removal of the needle by placing a pledget of gelfoam at the puncture sites. Saline is injected as the needle is removed to
5 ensure no spillage of cells into the peritoneal cavity or along the needle track. The general anesthetic is terminated, and the animal returned to the animal care center and placed on a normal diet.

Two weeks later, general anesthetic is administered, and utilizing aseptic precautions, the hepatic lobe containing the tumor is identified through
10 a midline incision. A 16 gauge angiographic needle is then inserted through the hepatic capsule into the tumor, a 0.038-inch guidewire passed through the needle, and the needle withdrawn over the guidewire. A number 5 French dilator is passed over the guide into the tumor and withdrawn. A number 5 French delivery catheter is then passed over the wire containing a self-
15 expanding stainless steel Wallstent (5 mm in diameter and 1 cm long). The stent is deployed into the tumor and the guidewire delivery catheter is removed. One-third of the rats have a conventional stainless steel stent inserted into the tumor, one-third a stainless steel stent coated with polymer, and one third a stent coated with the polymer-anti-angiogenic factor compound. The general
20 anesthetic is terminated and the rat returned to the animal care facility.

A plain abdominal X-ray is performed at 2 days in order to assess the degree of stent opening. Rats are sacrificed at 2, 7, 14, 28 and 56 days post-stent insertion by injecting Euthanyl, and their livers removed *en bloc* once euthanasia is confirmed. After fixation in formaldehyde for 48 hours, the liver is
25 sectioned at 0.5 mm intervals; including severing the stent transversely using a fresh blade for each slice. Histologic sections stained with H and E are then analyzed to assess the degree of tumor ingrowth into the stent lumen.

30

EXAMPLE 8

MANUFACTURE OF MICROSPHERES

Equipment which is preferred for the manufacture of microspheres described below include: 200 ml water jacketed beaker (Kimax or
35 Pyrex), Haake circulating water bath, overhead stirrer and controller with 2 inch diameter (4 blade, propeller type stainless steel stirrer - Fisher brand), 500 ml glass beaker, hot plate/stirrer (Corning brand), 4 X 50 ml polypropylene

centrifuge tubes (Nalgene), glass scintillation vials with plastic insert caps, table top centrifuge (GPR Beckman), high speed centrifuge- floor model (JS 21 Beckman), Mettler analytical balance (AJ 100, 0.1 mg), Mettler digital top loading balance (AE 163, 0.01 mg), automatic pipetter (Gilson). Reagents
5 include Polycaprolactone ("PCL" - mol wt 10,000 to 20,000; Polysciences, Warrington Pennsylvania, USA), "washed" Ethylene Vinyl Acetate ("EVA" washed so as to remove the anti-oxidant BHT), Poly(DL)lactic acid ("PLA" - mol wt 15,000 to 25,000; Polysciences), Polyvinyl Alcohol ("PVA" - mol wt 124,000 to 186,000; 99% hydrolyzed; Aldrich Chemical Co., Milwaukee WI,
10 USA), Dichloromethane ("DCM" or "methylene chloride"; HPLC grade Fisher scientific), and distilled water.

A. Preparation of 5% (w/v) Polymer Solutions

15 Depending on the polymer solution being prepared, 1.00 g of PCL or PLA, or 0.50 g each of PLA and washed EVA is weighed directly into a 20 ml glass scintillation vial. Twenty milliliters of DCM is then added, and the vial tightly capped. The vial is stored at room temperature (25°C) for one hour (occasional shaking may be used), or until all the polymer has dissolved (the
20 solution should be clear). The solution may be stored at room temperature for at least two weeks.

B. Preparation of 5% (w/v) Stock Solution of PVA

25 Twenty-five grams of PVA is weighed directly into a 600 ml glass beaker. Five hundred milliliters of distilled water is added, along with a 3 inch Teflon coated stir bar. The beaker is covered with glass to decrease evaporation losses, and placed into a 2000 ml glass beaker containing 300 ml of water (which acts as a water bath). The PVA is stirred at 300 rpm at 85°C (Corning hot
30 plate/stirrer) for 2 hours or until fully dissolved. Dissolution of the PVA may be determined by a visual check; the solution should be clear. The solution is then transferred to a glass screw top storage container and stored at 4°C for a maximum of two months. The solution, however should be warmed to room temperature before use or dilution.

C. Procedure for Producing Microspheres

Based on the size of microspheres being made (see Table 1), 100 ml of the PVA solution (concentrations given in Table III) is placed into the 200 ml water jacketed beaker. Haake circulating water bath is connected to this beaker and the contents are allowed to equilibrate at 27°C (+/-10°C) for 10 minutes. Based on the size of microspheres being made (see Table III), the start speed of the overhead stirrer is set, and the blade of the overhead stirrer placed half way down in the PVA solution. The stirrer is then started, and 10 ml of polymer solution (polymer solution used based on type of microspheres being produced) is then dripped into the stirring PVA over a period of 2 minutes using a 5 ml automatic pipetter. After 3 minutes the stir speed is adjusted (see Table III), and the solution stirred for an additional 2.5 hours. The stirring blade is then removed from the microsphere preparation, and rinsed with 10 ml of distilled water so that the rinse solution drains into the microsphere preparation. The microsphere preparation is then poured into a 500 ml beaker, and the jacketed water bath washed with 70 ml of distilled water, which is also allowed to drain into the microsphere preparation. The 180 ml microsphere preparation is then stirred with a glass rod, and equal amounts are poured into four polypropylene 50 ml centrifuge tubes. The tubes are then capped, and centrifuged for 10 minutes (force given in Table 1). A 5 ml automatic pipetter or vacuum suction is then utilized to draw 45 ml of the PVA solution off of each microsphere pellet.

TABLE III

PVA concentrations, stir speeds, and centrifugal force requirements for each diameter range of microspheres.

5 STAGE	MICROSPHERE DIAMETER RANGES		
	30 μm to 100 μm	10 μm to 30 μm	0.1 μm to 3 μm
10 PVA Concentration	2.5% (w/v) (i.e., dilute 5% stock with distilled water)	5% (w/v) (i.e., undiluted stock)	3.5% (w/v) (i.e., dilute 5% stock with distilled water)
15 Starting Stir Speed	500 rpm +/- 50 rpm	500 rpm +/- 50 rpm	3000 rpm +/- 200 rpm
20 Adjusted Stir Speed	500 rpm +/- 50 rpm	500 rpm +/- 50 rpm	2500 rpm +/- 200 rpm
25 Centrifuge Force	1000 g +/- 100 g (Table top model)	1000 g +/- 100 g (Table top model)	10 000 g +/- 1000 g (High speed model)

Five milliliters of distilled water is then added to each centrifuge tube, which is then vortexed to resuspend the microspheres. The four microsphere suspensions are then pooled into one centrifuge tube along with 20 ml of distilled water, and centrifuged for another 10 minutes (force given in Table 1). This process is repeated two additional times for a total of three washes. The microspheres are then centrifuged a final time, and resuspended in 10 ml of distilled water. After the final wash, the microsphere preparation is transferred into a preweighed glass scintillation vial. The vial is capped, and left overnight at room temperature (25°C) in order to allow the microspheres to sediment out under gravity. Microspheres which fall in the size range of 0.1 μm to 3 μm do not sediment out under gravity, so they are left in the 10 ml suspension.

D. Drying of 10 μm to 30 μm or 30 μm to 100 μm Diameter Microspheres

After the microspheres have sat at room temperature overnight, a
5 5 ml automatic pipetter or vacuum suction is used to draw the supernatant off of
the sedimented microspheres. The microspheres are allowed to dry in the
uncapped vial in a drawer for a period of one week or until they are fully dry
(vial at constant weight). Faster drying may be accomplished by leaving the
uncapped vial under a slow stream of nitrogen gas (flow approx. 10 ml/min.) in
10 the fume hood. When fully dry (vial at constant weight), the vial is weighed and
capped. The labelled, capped vial is stored at room temperature in a drawer.
Microspheres are normally stored no longer than 3 months.

E. Drying of 0.1 μm to 3 μm Diameter Microspheres

15

This size range of microspheres will not sediment out, so they are
left in suspension at 4°C for a maximum of four weeks. To determine the
concentration of microspheres in the 10 ml suspension, a 200 μl sample of the
suspension is pipetted into a 1.5 ml preweighed microfuge tube. The tube is
20 then centrifuged at 10,000 g (Eppendorf table top microfuge), the supernatant
removed, and the tube allowed to dry at 50°C overnight. The tube is then
reweighed in order to determine the weight of dried microspheres within the
tube.

25

F. Manufacture of Taxol Loaded Microsphere

In order to prepare taxol containing microspheres, an appropriate
amount of weighed taxol (based upon the percentage of taxol to be
encapsulated) is placed directly into a 20 ml glass scintillation vial. Ten
30 milliliters of an appropriate polymer solution is then added to the vial
containing the taxol, which is then vortexed until the taxol has dissolved.

Microspheres containing taxol may then be produced essentially
as described above in steps (C) through (E).

35

EXAMPLE 9

MANUFACTURE OF STENT COATING

Reagents and equipment which are utilized within the following
5 experiments include (medical grade stents obtained commercially from a variety
of manufacturers; e.g., the "Strecker" stent) and holding apparatus, 20 ml glass
scintillation vial with cap (plastic insert type), TLC atomizer, Nitrogen gas tank,
glass test tubes (various sizes from 1 ml and up), glass beakers (various sizes),
Pasteur pipette, tweezers, Polycaprolactone ("PCL" - mol wt 10,000 to 20,000;
10 Polysciences), Taxol (Sigma Chemical Co., St. Louis, Mo., 95% purity), Ethylene
vinyl acetate ("EVA" - washed - see previous), Poly(DL)lactic acid ("PLA" - mol
wt 15,000 to 25,000; Polysciences), dichloromethane ("DCM" - HPLC grade,
Fisher Scientific).

15 A. Procedure for Sprayed Stents

The following describes a typical method using a 3 mm crimped
diameter interleaving metal wire stent of approximately 3 cm length. For larger
diameter stents, larger volumes of polymer/drug solution are used.

20 Weigh sufficient polymer directly into a 20 ml glass scintillation
vial and add sufficient DCM to achieve a 2% w/v solution. Cap the vial and mix
the solution to dissolve the polymer (hand shaking). Assemble the stent in a
vertical orientation. This can be accomplished using a piece of nylon and tying
the stent to a retort stand. Position this stent holding apparatus 6 to 12 inches
25 above the fume hood floor on a suitable support (e.g., inverted 2000 ml glass
beaker) to enable horizontal spraying. Using an automatic pipette, transfer a
suitable volume (minimum 5 ml) of the 2% polymer solution to a separate 20 ml
glass scintillation vial. Add an appropriate amount of taxol to the solution and
dissolve it by hand shaking the capped vial.

30 To prepare for spraying, remove the cap of this vial and dip the
barrel (only) of an TLC atomizer into the polymer solution. Note that the
reservoir of the atomizer need not be used in this procedure: the 20 ml glass
vial acts as a reservoir. Connect the nitrogen tank to the gas inlet of the
atomizer. Gradually increase the pressure until atomization and spraying
35 begins. Note the pressure and use this pressure throughout the procedure. To
spray the stent use 5 second oscillating sprays with a 15 second dry time between
sprays. After 5 sprays, rotate the stent 90° and spray that portion of the stent.

Repeat until all sides of the stent have been sprayed. During the dry time, finger crimp the gas line to avoid wastage of the spray. Spraying is continued until a suitable amount of polymer is deposited on the stents. The amount may be based on the specific stent application *in vivo*. To determine the amount, weigh the stent after spraying has been completed and the stent has dried. Subtract the original weight of the stent from the finished weight and this produces the amount of polymer (plus taxol) applied to the stent. Store the coated stent in a sealed container.

10 B. Procedure for Dipped Stents

The following describes a typical method using a 3 mm crimped diameter interleaving metal wire stent of approximately 3 cm length. For larger diameter stents, larger volumes of polymer/drug solution are used in larger sized test tubes.

15 Weigh 2 g of EVA into a 20 ml glass scintillation vial and add 20 ml of DCM. Cap the vial and leave it for 2 hours to dissolve (hand shake the vial frequently to assist the dissolving process). Weigh a known weight of taxol directly into a 1 ml glass test tube and add 0.5 ml of the polymer solution. Using a glass Pasteur pipette, dissolve the taxol by gently pumping the polymer solution. Once the taxol is dissolved, hold the test tube in a near horizontal position (the sticky polymer solution will not flow out). Using tweezers, insert the stent into the tube all the way to the bottom. Allow the polymer solution to flow almost to the mouth of the test tube by angling the mouth below horizontal and then restoring the test tube to an angle slightly above the horizontal. While slowly rotating the stent in the tube, slowly remove the stent (approximately 30 seconds).

25 Hold the stent in a vertical position to dry. Some of the *sealed* perforations may *pop* so that a hole exists in the continuous sheet of polymer. This may be remedied by repeating the previous dipping procedure, however repetition of the procedure can also lead to further popping and a general uneven build up of polymer. Generally, it is better to dip the stent just once and to cut out a section of stent that has no *popped* perforations. Store the dipped stent in a sealed container.

EXAMPLE 10

MANUFACTURE OF SURGICAL "PASTES"

As noted above, the present invention provides a variety of
5 polymeric-containing drug compositions that may be utilized within a variety of
clinical situations. For example, compositions may be produced: (1) as a
"thermopaste" that is applied to a desired site as a fluid, and hardens to a solid
of the desired shape at a specified temperature (e.g., body temperature); (2) as a
10 spray (*i.e.*, "nanospray") which may delivered to a desired site either directly or
through a specialized apparatus (e.g., endoscopy), and which subsequently
hardens to a solid which adheres to the tissue to which it is applied; (3) as an
adherent, pliable, resilient, angiogenesis inhibitor-polymer film applied to a
desired site either directly or through a specialized apparatus, and which
preferably adheres to the site to which it is applied; and (4) as a fluid composed
15 of a suspension of microspheres in an appropriate carrier medium, which is
applied to a desired site either directly or via a specialized apparatus, and which
leaves a layer of microspheres at the application site. Representative examples
of each of the above embodiments is set forth in more detail below.

20 A. Procedure for Producing Thermopaste

Reagents and equipment which are utilized within the following
experiments include a sterile glass syringe (1 ml), Corning hot plate/stirrer, 20
ml glass scintillation vial, moulds (e.g., 50 μ l DSC pan or 50 ml centrifuge tube
25 cap inner portion), scalpel and tweezers, Polycaprolactone ("PCL" - mol wt
10,000 to 20,000; Polysciences, Warrington, Pennsylvania USA), and Taxol
(Sigma grade 95% purity minimum).

Weigh 5.00 g of polycaprolactone directly into a 20 ml glass
scintillation vial. Place the vial in a 600 ml beaker containing 50 ml of water.
30 Gently heat the beaker to 65°C and hold it at that temperature for 20 minutes.
This allows the polymer to melt. Thoroughly mix a known weight of taxol, or
other angiogenesis inhibitor into the melted polymer at 65°C. Pour the melted
polymer into a prewarmed (60°C oven) mould. Use a spatula to assist with the
pouring process. Allow the mould to cool so the polymer solidifies. Cut or
35 break the polymer into small pieces (approximately 2 mm by 2 mm in size).
These pieces must fit into a 1 ml glass syringe. Remove the plunger from the 1

ml glass syringe (do not remove the cap from the tip) and place it on a balance. Zero the balance.

Weigh 0.5 g of the pieces directly into the open end of the syringe. Place the glass syringe upright (capped tip downwards) into a 500 ml glass
5 beaker containing distilled water at 65°C (corning hot plate) so that no water enters the barrel. The polymer melts completely within 10 minutes in this apparatus. When the polymer pieces have melted, remove the barrel from the water bath, hold it horizontally and remove the cap. Insert the plunger into the
10 barrel and compress the melted polymer into a sticky mass at the tip end of the barrel. Cap the syringe and allow it to cool to room temperature.

For application, the syringe may be reheated to 60°C and administered as a liquid which solidifies when cooled to body temperature.

B. Procedure for Producing Nanospray

15 Nanospray is a suspension of small microspheres in saline. If the microspheres are very small (*i.e.*, under 1 μm in diameter) they form a colloid so that the suspension will not sediment under gravity. As is described in more
20 detail below, a suspension of 0.1 μm to 1 μm microparticles may be created suitable for deposition onto tissue through a finger pumped aerosol. Equipment and materials which may be utilized to produce nanospray include 200 ml water
25 jacketed beaker (Kimax or Pyrex), Haake circulating water bath, overhead stirrer and controller with 2 inch diameter (4 blade, propeller type stainless steel stirrer; Fisher brand), 500 ml glass beaker, hot plate/stirrer (Corning brand), 4 X 50 ml polypropylene centrifuge tubes (Nalgene), glass scintillation vials with
30 plastic insert caps, table top centrifuge (Beckman), high speed centrifuge - floor model (JS 21 Beckman), Mettler analytical balance (AJ 100, 0.1 mg), Mettler digital top loading balance (AE 163, 0.01 mg), automatic pipetter (Gilson), sterile pipette tips, pump action aerosol (Pfeiffer pharmaceuticals) 20 ml,
35 laminar flow hood, Polycaprolactone ("PCL" - mol wt 10,000 to 20,000; Polysciences, Warrington, Pennsylvania USA), "washed" (see previous) Ethylene Vinyl Acetate ("EVA"), Poly(DL)lactic acid ("PLA" mol wt 15,000 to 25,000; Polysciences), Polyvinyl Alcohol ("PVA" - mol wt 124,000 to 186,000; 99% hydrolyzed; Aldrich Chemical Co., Milwaukee, WI USA), Dichloromethane ("DCM" or "methylene chloride;" HPLC grade Fisher scientific), Distilled water, sterile saline (Becton and Dickenson or equivalent)

1. *Preparation of 5% (w/v) Polymer Solutions*

Depending on the polymer solution being prepared, weigh 1.00 g of PCL or PLA or 0.50 g each of PLA and washed EVA directly into a 20 ml glass scintillation vial. Using a measuring cylinder, add 20 ml of DCM and tightly cap the vial. Leave the vial at room temperature (25°C) for one hour or until all the polymer has dissolved (occasional hand shaking may be used). Dissolving of the polymer can be determined by a visual check; the solution should be clear. Label the vial with the name of the solution and the date it was produced. Store the solutions at room temperature and use within two weeks.

10

2. *Preparation of 3.5% (w/v) Stock Solution of PVA*

The solution can be prepared by following the procedure given below, or by diluting the 5% (w/v) PVA stock solution prepared for production of microspheres (see Example 8). Briefly, 17.5 g of PVA is weighed directly into a 600 ml glass beaker, and 500 ml of distilled water is added. Place a 3 inch teflon coated stir bar in the beaker. Cover the beaker with a cover glass to reduce evaporation losses. Place the beaker in a 2000 ml glass beaker containing 300 ml of water. This will act as a water bath. Stir the PVA at 300 rpm at 85°C (Corning hot plate/stirrer) for 2 hours or until fully dissolved. Dissolving of the PVA can be determined by a visual check; the solution should be clear. Use a pipette to transfer the solution to a glass screw top storage container and store at 4°C for a maximum of two months. This solution should be warmed to room temperature before use or dilution.

15

20

25

3. *Procedure for Producing Nanospray*

Place the stirring assembly in a fume hood. Place 100 ml of the 3.5% PVA solution in the 200 ml water jacketed beaker. Connect the Haake water bath to this beaker and allow the contents to equilibrate at 27°C (+/-1°C) for 10 minutes. Set the start speed of the overhead stirrer at 3000 rpm (+/- 200 rpm). Place the blade of the overhead stirrer half way down in the PVA solution and start the stirrer. Drip 10 ml of polymer solution (polymer solution used based on type of nanospray being produced) into the stirring PVA over a period of 2 minutes using a 5 ml automatic pipetter. After 3 minutes, adjust the stir speed to 2500 rpm (+/- 200 rpm) and leave the assembly for 2.5 hours. After 2.5 hours, remove the stirring blade from the nanospray preparation and rinse with 10 ml of distilled water. Allow the rinse solution to go into the nanospray preparation.

30

35

Pour the microsphere preparation into a 500 ml beaker. Wash the jacketed water bath with 70 ml of distilled water. Allow the 70 ml rinse solution to go into the microsphere preparation. Stir the 180 ml microsphere preparation with a glass rod and pour equal amounts of it into four polypropylene 50 ml centrifuge tubes. Cap the tubes. Centrifuge the capped tubes at 10 000 g (+/- 1000 g) for 10 minutes. Using a 5 ml automatic pipetter or vacuum suction, draw 45 ml of the PVA solution off of each microsphere pellet and discard it. Add 5 ml of distilled water to each centrifuge tube and use a vortex to resuspend the microspheres in each tube. Using 20 ml of distilled water, pool the four microsphere suspensions into one centrifuge tube. To wash the microspheres, centrifuge the nanospray preparation for 10 minutes at 10 000 g (+/- 1000 g). Draw the supernatant off of the microsphere pellet. Add 40 ml of distilled water and use a vortex to resuspend the microspheres. Repeat this process two more times for a total of three washes. Do a fourth wash but use only 10 ml (not 40 ml) of distilled water when resuspending the microspheres. After the fourth wash, transfer the microsphere preparation into a preweighed glass scintillation vial.

Cap the vial and let it sit for 1 hour at room temperature (25°C) to allow the 2 μm and 3 μm diameter microspheres to sediment out under gravity. After 1 hour, draw off the top 9 ml of suspension using a 5 ml automatic pipetter. Place the 9 ml into a sterile capped 50 ml centrifuge tube. Centrifuge the suspension at 10 000 g (+/- 1000 g) for 10 minutes. Discard the supernatant and resuspend the pellet in 20 ml of sterile saline. Centrifuge the suspension at 10 000 g (+/- 1000 g) for 10 minutes. Discard the supernatant and resuspend the pellet in sterile saline. The quantity of saline used is dependent on the final required suspension concentration (usually 10% w/v). Thoroughly rinse the aerosol apparatus in sterile saline and add the nanospray suspension to the aerosol.

30 C. Manufacture of Taxol Loaded Nanospray

To manufacture nanospray containing taxol, use Taxol (Sigma grade 95% purity). To prepare the polymer drug stock solution, weigh the appropriate amount of taxol directly into a 20 ml glass scintillation vial. The appropriate amount is determined based on the percentage of taxol to be in the nanospray. For example, if nanospray containing 5% taxol was required, then

the amount of taxol weighed would be 25 mg since the amount of polymer added is 10 ml of a 5% polymer in DCM solution (see next step).

Add 10 ml of the appropriate 5% polymer solution to the vial containing the taxol. Cap the vial and vortex or hand swirl it to dissolve the taxol (visual check to ensure taxol dissolved). Label the vial with the date it was produced. This is to be used the day it is produced.

Follow the procedures as described above, except that polymer/drug (e.g., taxol) stock solution is substituted for the polymer solution.

10 D. Procedure for Producing Film

The term film refers to a polymer formed into one of many geometric shapes. The film may be a thin, elastic sheet of polymer or a 2 mm thick disc of polymer. This film is designed to be placed on exposed tissue so that any encapsulated drug is released from the polymer over a long period of time at the tissue site. Films may be made by several processes, including for example, by casting, and by spraying.

In the casting technique, polymer is either melted and poured into a shape or dissolved in dichloromethane and poured into a shape. The polymer then either solidifies as it cools or solidifies as the solvent evaporates, respectively. In the spraying technique, the polymer is dissolved in solvent and sprayed onto glass, as the solvent evaporates the polymer solidifies on the glass. Repeated spraying enables a build up of polymer into a film that can be peeled from the glass.

25 Reagents and equipment which were utilized within these experiments include a small beaker, Corning hot plate stirrer, casting moulds (e.g., 50 ml centrifuge tube caps) and mould holding apparatus, 20 ml glass scintillation vial with cap (Plastic insert type), TLC atomizer, Nitrogen gas tank, Polycaprolactone ("PCL" - mol wt 10,000 to 20,000; Polysciences), Taxol (Sigma 95% purity), Ethanol, "washed" (see previous) Ethylene vinyl acetate ("EVA"), Poly(DL)lactic acid ("PLA" - mol wt 15,000 to 25,000; Polysciences), Dichloromethane (HPLC grade Fisher Scientific).

1. *Procedure for Producing Films - Melt Casting*

35 Weigh a known weight of PCL directly into a small glass beaker. Place the beaker in a larger beaker containing water (to act as a water bath) and put it on the hot plate at 70°C for 15 minutes or until the polymer has fully

melted. Add a known weight of drug to the melted polymer and stir the mixture thoroughly. To aid dispersion of the drug in the melted PCL, the drug may be suspended/dissolved in a small volume (<10% of the volume of the melted PCL) of 100% ethanol. This ethanol suspension is then mixed into the melted
5 polymer. Pour the melted polymer into a mould and let it to cool. After cooling, store the film in a container.

2. Procedure for Producing Films - Solvent Casting

Weigh a known weight of PCL directly into a 20 ml glass
10 scintillation vial and add sufficient DCM to achieve a 10% w/v solution. Cap the vial and mix the solution. Add sufficient taxol to the solution to achieve the desired final taxol concentration. Use hand shaking or vortexing to dissolve the taxol in the solution. Let the solution sit for one hour (to diminish the presence of air bubbles) and then pour it slowly into a mould. The mould used
15 is based on the shape required. Place the mould in the fume hood overnight. This will allow the DCM to evaporate. Either leave the film in the mould to store it or peel it out and store it in a sealed container.

3. Procedure for Producing Films - Sprayed

Weigh sufficient polymer directly into a 20 ml glass scintillation
20 vial and add sufficient DCM to achieve a 2% w/v solution. Cap the vial and mix the solution to dissolve the polymer (hand shaking). Assemble the moulds in a vertical orientation in a suitable mould holding apparatus in the fume hood. Position this mould holding apparatus 6 to 12 inches above the fume hood floor
25 on a suitable support (e.g., inverted 2000 ml glass beaker) to enable horizontal spraying. Using an automatic pipette, transfer a suitable volume (minimum 5 ml) of the 2% polymer solution to a separate 20 ml glass scintillation vial. Add sufficient taxol to the solution and dissolve it by hand shaking the capped vial. To prepare for spraying, remove the cap of this vial and dip the barrel (only) of
30 an TLC atomizer into the polymer solution. Note: the reservoir of the atomizer is not used in this procedure - the 20 ml glass vial acts as a reservoir.

Connect the nitrogen tank to the gas inlet of the atomizer. Gradually increase the pressure until atomization and spraying begins. Note the pressure and use this pressure throughout the procedure. To spray the moulds
35 use 5 second oscillating sprays with a 15 second dry time between sprays. During the dry time, finger crimp the gas line to avoid wastage of the spray. Spraying is continued until a suitable thickness of polymer is deposited on the

mould. The thickness is based on the request. Leave the sprayed films attached to the moulds and store in sealed containers.

E. Procedure for Producing Nanopaste

5

Nanopaste is a suspension of microspheres suspended in a hydrophilic gel. Within one aspect of the invention, the gel or paste can be smeared over tissue as a method of locating drug loaded microspheres close to the target tissue. Being water based, the paste will soon become diluted with
10 bodily fluids causing a decrease in the stickiness of the paste and a tendency of the microspheres to be deposited on nearby tissue. A pool of microsphere encapsulated drug is thereby located close to the target tissue.

Reagents and equipment which were utilized within these experiments include glass beakers, Carbopol 925 (pharmaceutical grade,
15 Goodyear Chemical Co.), distilled water, sodium hydroxide (1 M) in water solution, sodium hydroxide solution (5 M) in water solution, microspheres in the 0.1 μm to 3 μm size range suspended in water at 20% w/v (See previous).

1. *Preparation of 5% w/v Carbopol Gel*

20 Add a sufficient amount of carbopol to 1 M sodium hydroxide to achieve a 5% w/v solution. To dissolve the carbopol in the 1 M sodium hydroxide, allow the mixture to sit for approximately one hour. During this time period, stir the mixture using a glass rod. After one hour, take the pH of the mixture. A low pH indicates that the carbopol is not fully dissolved. The pH
25 you want to achieve is 7.4. Use 5 M sodium hydroxide to adjust the pH. This is accomplished by *slowly* adding drops of 5 M sodium hydroxide to the mixture, stirring the mixture and taking the pH of the mixture. It usually takes approximately one hour to adjust the pH to 7.4. Once a pH of 7.4 is achieved, cover the gel and let it sit for 2 to 3 hours. After this time period, check the pH
30 to ensure it is still at 7.4. If it has changed, adjust back to pH 7.4 using 5 M sodium hydroxide. Allow the gel to sit for a few hours to ensure the pH is stable at 7.4. Repeat the process until the desired pH is achieved and is stable. Label the container with the name of the gel and the date. The gel is to be used to make nanopaste within the next week.

35

2. Procedure for Producing Nanopaste

Add sufficient 0.1 μm to 3 μm microspheres to water to produce a 20% suspension of the microspheres. Put 8 ml of the 5% w/v carbopol gel in a glass beaker. Add 2 ml of the 20% microsphere suspension to the beaker.
5 Using a glass rod or a mixing spatula, stir the mixture to thoroughly disperse the microspheres throughout the gel. This usually takes 30 minutes. Once the microspheres are dispersed in the gel, place the mixture in a storage jar. Store the jar at 4°C. It must be used within a one month period.

10

EXAMPLE 11

CONTROLLED DELIVERY OF TAXOL FROM MICROSPHERES COMPOSED OF A BLEND OF ETHYLENE-VINYL-ACETATE COPOLYMER AND POLY (D,L LACTIC ACID). IN VIVO TESTING OF THE MICROSPHERES ON THE CAM ASSAY

15

This example describes the preparation of taxol-loaded microspheres composed of a blend of biodegradable poly (d,l-lactic acid) (PLA) polymer and nondegradable ethylene-vinyl acetate (EVA) copolymer. In addition, the *in vitro* release rate and anti-angiogenic activity of taxol released
20 from microspheres placed on a CAM are demonstrated.

Reagents which were utilized in these experiments include taxol, which is purchased from Sigma Chemical Co. (St. Louis, MO); PLA (molecular weight 15,000-25,000) and EVA (60% vinyl acetate) (purchased from Polysciences (Warrington, PA); polyvinyl alcohol (PVA) (molecular weight
25 124,000-186,000, 99% hydrolysed, purchased from Aldrich Chemical Co. (Milwaukee, WI)) and Dichloromethane (DCM) (HPLC grade, obtained from Fisher Scientific Co). Distilled water is used throughout.

30

A. Preparation of microspheres

Microspheres are prepared essentially as described in Example 8 utilizing the solvent evaporation method. Briefly, 5% w/v polymer solutions in 20 mL DCM are prepared using blends of EVA:PLA between 35:65 to 90:10. To 5 mL of 2.5% w/v PVA in water in a 20 mL glass vial is added 1 mL of the
35 polymer solution dropwise with stirring. Six similar vials are assembled in a six position overhead stirrer, dissolution testing apparatus (Vanderkamp) and stirred at 200 rpm. The temperature of the vials is increased from room

temperature to 40°C over 15 min and held at 40°C for 2 hours. Vials are centrifuged at 500xg and the microspheres washed three times in water. At some EVA:PLA polymer blends, the microsphere samples aggregated during the washing stage due to the removal of the dispersing or emulsifying agent, PVA. This aggregation effect could be analyzed semi-quantitatively since aggregated microspheres fused and the fused polymer mass floated on the surface of the wash water. This surface polymer layer is discarded during the wash treatments and the remaining, pelleted microspheres are weighed. The % aggregation is determined from

10

$$\% \text{ aggregation} = \frac{1 - (\text{weight of pelleted microspheres})}{\text{initial polymer weight}} \times 100$$

Taxol loaded microspheres (0.6% w/w taxol) are prepared by dissolving the taxol in the 5% w/v polymer solution in DCM. The polymer blend used is 50:50 EVA:PLA. A "large" size fraction and "small" size fraction of microspheres are produced by adding the taxol/polymer solution dropwise into 2.5% w/v PVA and 5% w/v PVA, respectively. The dispersions are stirred at 40°C at 200 rpm for 2 hours, centrifuged and washed 3 times in water as described previously. Microspheres are air dried and samples are sized using an optical microscope with a stage micrometer. Over 300 microspheres are counted per sample. Control microspheres (taxol absent) are prepared and sized as described previously.

25

B. Encapsulation efficiency

Known weights of taxol-loaded microspheres are dissolved in 1 mL DCM, 20 mL of 40% acetonitrile in water at 50°C are added and vortexed until the DCM had been evaporated. The concentration of taxol in the 40% acetonitrile is determined by HPLC using a mobile phase of water:methanol:acetonitrile (37:5:58) at a flow rate of 1 mL/min (Beckman isocratic pump), a C8 reverse phase column (Beckman) and UV detection at 232 nm. To determine the recovery efficiency of this extraction procedure, known weights of taxol from 100-1000 µg are dissolved in 1 mL of DCM and subjected to the same extraction procedure in triplicate as described previously. Recoveries are always greater than 85% and the values of encapsulation efficiency are corrected appropriately.

C. Drug release studies

In 15 mL glass, screw capped tubes are placed 10 mL of 10 mM
5 phosphate buffered saline (PBS), pH 7.4 and 35 mg taxol-loaded microspheres.
The tubes are tumbled at 37°C and at given time intervals, centrifuged at 1500xg
for 5 min and the supernatant saved for analysis. Microsphere pellets are
resuspended in fresh PBS (10mL) at 37°C and reincubated. Taxol
concentrations are determined by extraction into 1 mL DCM followed by
10 evaporation to dryness under a stream of nitrogen, reconstitution in 1 mL of
40% acetonitrile in water and analysis using HPLC as previously described.

D. Scanning Electron Microscopy (SEM)

15 Microspheres are placed on sample holders, sputter coated with
gold and micrographs obtained using a Philips 501B SEM operating at 15 kV.

E. CAM Studies

20 Fertilized, domestic chick embryos are incubated for 4 days prior
to shell-less culturing. The egg contents are incubated at 90% relative humidity
and 3% CO₂ for 2 days. On day 6 of incubation, 1 mg aliquots of 0.6% taxol
loaded or control (taxol free) microspheres are placed directly on the CAM
surface. After a 2 day exposure the vasculature is examined using a
25 stereomicroscope interfaced with a video camera; the video signals are then
displayed on a computer and video printed.

F. Results

30 Microspheres prepared from 100% EVA are freely suspended in
solutions of PVA but aggregated and coalesced or fused extensively on
subsequent washing in water to remove the PVA. Blending EVA with an
increasing proportion of PLA produced microspheres showing a decreased
tendency to aggregate and coalesce when washed in water, as described in
35 Figure 15A. A 50:50 blend of EVA:PLA formed microspheres with good
physical stability, that is the microspheres remained discrete and well suspended
with negligible aggregation and coalescence.

The size range for the "small" size fraction microspheres is determined to be >95% of the microsphere sample (by weight) between 10-30 mm and for the "large" size fraction, >95% of the sample (by weight) between 30-100 mm. Representative scanning electron micrographs of taxol loaded 50:50 EVA:PLA microspheres in the "small" and "large" size ranges are shown in Figures 15B and 15C, respectively. The microspheres are spherical with a smooth surface and with no evidence of solid drug on the surface of the microspheres. The efficiency of loading 50:50 EVA:PLA microspheres with taxol is between 95-100% at initial taxol concentrations of between 100-1000 mg taxol per 50 mg polymer. There is no significant difference (Student t-test, $p < 0.05$) between the encapsulation efficiencies for either "small" or "large" microspheres.

The time course of taxol release from 0.6% w/v loaded 50:50 EVA:PLA microspheres is shown in Figure 15D for "small" size (open circles) and "large" size (closed circles) microspheres. The release rate studies are carried out in triplicate tubes in 3 separate experiments. The release profiles are biphasic with an initial rapid release of taxol or "burst" phase occurring over the first 4 days from both size range microspheres. This is followed by a phase of much slower release. There is no significant difference between the release rates from "small" and "large" microspheres. Between 10-13% of the total taxol content of the microspheres is released in 50 days.

The taxol loaded microspheres (0.6% w/v loading) are tested using the CAM assay and the results are shown in Figure 15E. The taxol microspheres released sufficient drug to produce a zone of avascularity in the surrounding tissue (Figure 15F). Note that immediately adjacent to the microspheres ("MS" in Figures 15E and 15F) is an area in which blood vessels are completely absent (Zone 1); further from the microspheres is an area of disrupted, non-functioning capillaries (Zone 2); it is only at a distance of approximately 6 mm from the microspheres that the capillaries return to normal. In CAMs treated with control microspheres (taxol absent) there is a normal capillary network architecture.

Discussion

Arterial chemoembolization is an invasive surgical technique. Therefore, ideally, a chemoembolic formulation of an anti-angiogenic and anticancer drug such as taxol would release the drug at the tumor site at

concentrations sufficient for activity for a prolonged period of time, of the order of several months. EVA is a tissue compatible nondegradable polymer which has been used extensively for the controlled delivery of macromolecules over long time periods (> 100 days).

5 EVA is initially selected as a polymeric biomaterial for preparing microspheres with taxol dispersed in the polymer matrix. However, microspheres prepared with 100% EVA aggregated and coalesced almost completely during the washing procedure.

10 Polymers and copolymers based on lactic acid and glycolic acid are physiologically inert and biocompatible and degrade by hydrolysis to toxicologically acceptable products. Copolymers of lactic acid and glycolic acids have faster degradation rates than PLA and drug loaded microspheres prepared using these copolymers are unsuitable for prolonged, controlled release over several months. Dollinger and Sawan blended PLA with EVA and showed that
15 the degradation lifetime of PLA is increased as the proportion of EVA in the blend is increased. They suggested that blends of EVA and PLA should provide a polymer matrix with better mechanical stability and control of drug release rates than PLA.

20 Figure 15A shows that increasing the proportion of PLA in a EVA:PLA blend decreased the extent of aggregation of the microsphere suspensions. Blends of 50% or less EVA in the EVA:PLA matrix produced physically stable microsphere suspensions in water or PBS. A blend of 50:50 EVA:PLA is selected for all subsequent studies.

25 Different size range fractions of microspheres could be prepared by changing the concentration of the emulsifier, PVA, in the aqueous phase. "Small" microspheres are produced at the higher PVA concentration of 5% w/v whereas "large" microspheres are produced at 2.5% w/v PVA. All other production variables are the same for both microsphere size fractions. The higher concentration of emulsifier gave a more viscous aqueous dispersion
30 medium and produced smaller droplets of polymer/taxol/DCM emulsified in the aqueous phase and thus smaller microspheres. The taxol loaded microspheres contained between 95-100% of the initial taxol added to the organic phase encapsulated within the solid microspheres. The low water solubility of taxol favoured partitioning into the organic phase containing the
35 polymer.

Release rates of taxol from the 50:50 EVA:PLA microspheres are very slow with less than 15% of the loaded taxol being released in 50 days. The

initial burst phase of drug release may be due to diffusion of drug from the superficial region of the microspheres (close to the microsphere surface).

The mechanism of drug release from nondegradable polymeric matrices such as EVA is thought to involve the diffusion of water through the dispersed drug phase within the polymer, dissolution of the drug and diffusion of solute through a series of interconnecting, fluid filled pores. Blends of EVA and PLA have been shown to be immiscible or bicontinuous over a range of 30 to 70% EVA in PLA. In degradation studies in PBS buffer at 37°C, following an induction or lag period, PLA hydrolytically degraded and eroded from the EVA:PLA polymer blend matrix leaving an inactive sponge-like skeleton. Although the induction period and rate of PLA degradation and erosion from the blended matrices depended on the proportion of PLA in the matrix and on process history, there is consistently little or no loss of PLA until after 40-50 days.

Although some erosion of PLA from the 50:50 EVA:PLA microspheres may have occurred within the 50 days of the *in vitro* release rate study (Figure 15C), it is likely that the primary mechanism of drug release from the polymer blend is diffusion of solute through a pore network in the polymer matrix.

At the conclusion of the release rate study, the microspheres are analyzed from the amount of drug remaining. The values for the percent of taxol remaining in the 50 day incubation microsphere samples are 94% +/- 9% and 89% +/- 12% for "large" and "small" size fraction microspheres, respectively.

Microspheres loaded with 6mg per mg of polymer (0.6%) provided extensive inhibition of angiogenesis when placed on the CAM of the embryonic chick (Figures 15E and 15F).

EXAMPLE 12

TAXOL ENCAPSULATION IN POLY(E-CAPROLACTONE) MICROSPHERES. INHIBITION OF ANGIOGENESIS ON THE CAM ASSAY BY TAXOL-LOADED MICROSPHERES

This example evaluates the *in vitro* release rate profile of taxol from biodegradable microspheres of poly(e-caprolactone) and demonstrates the anti-angiogenic activity of taxol released from these microspheres when placed on the CAM.

Reagents which were utilized in these experiments include: poly(ϵ -caprolactone) ("PCL") (molecular weight 35,000 - 45,000; purchased from Polysciences (Warrington, PA)); dichloromethane ("DCM") from Fisher Scientific Co., Canada; polyvinyl alcohol (PVP) (molecular weight 12,000 - 18,000, 99% hydrolysed) from Aldrich Chemical Co. (Milwaukee, Wis.), and taxol from Sigma Chemical Co. (St. Louis, MO). Unless otherwise stated all chemicals and reagents are used as supplied. Distilled water is used throughout.

A. Preparation of microspheres

10

Microspheres are prepared essentially as described in Example 8 utilizing the solvent evaporation method. Briefly, 5%w/w taxol loaded microspheres are prepared by dissolving 10 mg of taxol and 190 mg of PCL in 2 ml of DCM, adding to 100 ml of 1% PVP aqueous solution and stirring at 1000 r.p.m. at 25°C for 2 hours. The suspension of microspheres is centrifuged at 1000 x g for 10 minutes (Beckman GPR), the supernatant removed and the microspheres washed three times with water. The washed microspheres are air-dried overnight and stored at room temperature. Control microspheres (taxol absent) are prepared as described above. Microspheres containing 1% and 2% taxol are also prepared. Microspheres are sized using an optical microscope with a stage micrometer.

15

20

B. Encapsulation efficiency

25

A known weight of drug-loaded microspheres (about 5 mg) is dissolved in 8 ml of acetonitrile and 2 ml distilled water is added to precipitate the polymer. The mixture is centrifuged at 1000 g for 10 minutes and the amount of taxol encapsulated is calculated from the absorbance of the supernatant measured in a UV spectrophotometer (Hewlett-Packard 8452A Diode Array Spectrophotometer) at 232 nm.

30

C. Drug release studies

About 10 mg of taxol-loaded microspheres are suspended in 20 ml of 10 mM phosphate buffered saline, pH 7.4 (PBS) in screw-capped tubes. The tubes are tumbled end-over-end at 37°C and at given time intervals 19.5 ml of supernatant is removed (after allowing the microspheres to settle at the

35

bottom), filtered through a 0.45 mm membrane filter and retained for taxol analysis. An equal volume of PBS is replaced in each tube to maintain sink conditions throughout the study. The filtrates are extracted with 3 x 1 ml DCM, the DCM extracts evaporated to dryness under a stream of nitrogen, redissolved
5 in 1 ml acetonitrile and analyzed by HPLC using a mobile phase of water:methanol:acetonitrile (37:5:58) at a flow rate of 1ml min⁻¹ (Beckman Isocratic Pump), a C8 reverse phase column (Beckman), and UV detection (Shimadzu SPD A) at 232 nm.

10 D. CAM studies

Fertilized, domestic chick embryos are incubated for 4 days prior to shell-less culturing. On day 6 of incubation, 1 mg aliquots of 5% taxol-loaded or control (taxol-free) microspheres are placed directly on the CAM surface.
15 After a 2-day exposure the vasculature is examined using a stereomicroscope interfaced with a video camera; the video signals are then displayed on a computer and video printed.

20 E. Scanning electron microscopy

Microspheres are placed on sample holders, sputter-coated with gold and then placed in a Philips 501B Scanning Electron Microscope operating at 15 kV.

25 F. Results

The size range for the microsphere samples is between 30 - 100 mm, although there is evidence in all taxol-loaded or control microsphere batches of some microspheres falling outside this range. The efficiency of
30 loading PCL microspheres with taxol is always greater than 95% for all drug loadings studied. Scanning electron microscopy demonstrated that the microspheres are all spherical and many showed a rough or pitted surface morphology. There appeared to be no evidence of solid drug on the surface of the microspheres.

35 The time courses of taxol release from 1%, 2% and 5% loaded PCL microspheres are shown in Figure 16A. The release rate profiles are biphasic. There is an initial rapid release of taxol or "burst phase" at all drug

loadings. The burst phase occurred over 1-2 days at 1% and 2% taxol loading and over 3-4 days for 5% loaded microspheres. The initial phase of rapid release is followed by a phase of significantly slower drug release. For microspheres containing 1% or 2% taxol there is no further drug release after
5 21 days. At 5% taxol loading, the microspheres had released about 20% of the total drug content after 21 days.

Figure 16B shows CAMs treated with control PCL microspheres, and Figure 16C shows treatment with 5% taxol loaded microspheres. The CAM with the control microspheres shows a normal capillary network architecture.
10 The CAM treated with taxol-PCL microspheres shows marked vascular regression and zones which are devoid of a capillary network.

G. Discussion

15 The solvent evaporation method of manufacturing taxol-loaded microspheres produced very high taxol encapsulation efficiencies of between 95-100%. This is due to the poor water solubility of taxol and its hydrophobic nature favouring partitioning in the organic solvent phase containing the polymer.

20 The biphasic release profile for taxol is typical of the release pattern for many drugs from biodegradable polymer matrices. Poly(ϵ -caprolactone) is an aliphatic polyester which can be degraded by hydrolysis under physiological conditions and it is non-toxic and tissue compatible. The degradation of PCL is significantly slower than that of the extensively
25 investigated polymers and copolymers of lactic and glycolic acids and is therefore suitable for the design of long-term drug delivery systems. The initial rapid or burst phase of taxol release is thought to be due to diffusional release of the drug from the superficial region of the microspheres (close to the microsphere surface). Release of taxol in the second (slower) phase of the
30 release profiles is not likely due to degradation or erosion of PCL because studies have shown that under *in vitro* conditions in water there is no significant weight loss or surface erosion of PCL over a 7.5-week period. The slower phase of taxol release is probably due to dissolution of the drug within fluid-filled pores in the polymer matrix and diffusion through the pores. The greater
35 release rate at higher taxol loading is probably a result of a more extensive pore network within the polymer matrix.

Taxol microspheres with 5% loading have been shown to release sufficient drug to produce extensive inhibition of angiogenesis when placed on the CAM. The inhibition of blood vessel growth resulted in an avascular zone as shown in Figure 16C.

5

EXAMPLE 13

TAXOL-LOADED POLYMERIC FILMS COMPOSED OF ETHYLENE VINYL ACETATE AND A SURFACTANT

10

Two types of films are prepared essentially as described in Example 10: pure EVA films loaded with taxol and EVA/surfactant blend films (*i.e.*, Pluronic F127, Span 80 and Pluronic L101) loaded with taxol.

The surfactants being examined are two hydrophobic surfactants (Span 80 and Pluronic L101) and one hydrophilic surfactant (Pluronic F127). The pluroinc surfactants are themselves polymers, which is an attractive property since they can be blended with EVA to optimize various drug delivery properties. Span 80 is a smaller molecule which is in some manner dispersed in the polymer matrix, and does not form a blend.

20

Surfactants will be useful in modulating the release rates of taxol from films and optimizing certain physical parameters of the films. One aspect of the surfactant blend films which indicates that drug release rates can be controlled is the ability to vary the rate and extent to which the compound will swell in water. Diffusion of water into a polymer-drug matrix is critical to the release of drug from the carrier. Figures 17C and 17D show the degree of swelling of the films as the level of surfactant in the blend is altered. Pure EVA films do not swell to any significant extent in over 2 months. However, by increasing the level of surfactant added to the EVA it is possible to increase the degree of swelling of the compound, and by increasing hydrophilicity swelling can also be increased.

30

Results of experiments with these films are shown below in Figures 17A-E. Briefly, Figure 17A shows taxol release (in mg) over time from pure EVA films. Figure 17B shows the percentage of drug remaining for the same films. As can be seen from these two figures, as taxol loading increases (*i.e.*, percentage of taxol by weight is increased), drug release rates increase, showing the expected concentration dependence. As taxol loading is increased,

35

the percent taxol remaining in the film also increases, indicating that higher loading may be more attractive for long-term release formulations.

Physical strength and elasticity of the films is assessed in Figure 17E. Briefly, Figure 17E shows stress/strain curves for pure EVA and EVA-Surfactant blend films. This crude measurement of stress demonstrates that the elasticity of films is increased with the addition of Pluronic F127, and that the tensile strength (stress on breaking) is increased in a concentration dependant manner with the addition of Pluronic F127. Elasticity and strength are important considerations in designing a film which can be manipulated for particular clinical applications without causing permanent deformation of the compound.

The above data demonstrates the ability of certain surfactant additives to control drug release rates and to alter the physical characteristics of the vehicle.

EXAMPLE 14

INCORPORATING METHOXYPOLYETHYLENE GLYCOL 350 (MePEG) INTO POLY(E-CAPROLACTONE) TO DEVELOP A FORMULATION FOR THE CONTROLLED DELIVERY OF TAXOL FROM A PASTE

Reagents and equipment which were utilized within these experiments include methoxypolyethylene glycol 350 ("MePEG" - Union Carbide, Danbury, CT). MePEG is liquid at room temperature, and has a freezing point of 10° to -5°C.

A. Preparation of a MePEG/PCL taxol-containing paste

MePEG/PCL paste is prepared by first dissolving a quantity of taxol into MePEG, and then incorporating this into melted PCL. One advantage with this method is that no DCM is required.

B. Analysis of melting point

The melting point of PCL/MePEG polymer blends may be determined by differential scanning calorimetry from 30°C to 70°C at a heating rate of 2.5°C per minute. Results of this experiment are shown in Figures 18A

and 18B. Briefly, as shown in Figure 18A the melting point of the polymer blend (as determined by thermal analysis) is decreased by MePEG in a concentration dependent manner. The melting point of the polymer blends as a function of MePEG concentration is shown in Figure 18A. This lower melting point also translates into an increased time for the polymer blends to solidify from melt as shown in Figure 18B. A 30:70 blend of MePEG:PCL takes more than twice as long to solidify from the fluid melt than does PCL alone.

C. Measurement of brittleness

10

Incorporation of MePEG into PCL appears to produce a less brittle solid, as compared to PCL alone. As a "rough" way of quantitating this, a weighted needle is dropped from an equal height into polymer blends containing from 0% to 30% MePEG in PCL, and the distance that the needle penetrates into the solid is then measured. The resulting graph is shown as Figure 18C. Points are given as the average of four measurements +/- 1 S.D.

15

For purposes of comparison, a sample of paraffin wax is also tested and the needle penetrated into this a distance of 7.25 mm +/- 0.3 mm.

20

D. Measurement of taxol release

Pellets of polymer (PCL containing 0%, 5%, 10% or 20% MePEG) are incubated in phosphate buffered saline (PBS, pH 7.4) at 37°C, and % change in polymer weight is measured over time. As can be seen in Figure 18D, the amount of weight lost increases with the concentration of MePEG originally present in the blend. It is likely that this weight loss is due to the release of MePEG from the polymer matrix into the incubating fluid. This would indicate that taxol will readily be released from a MePEG/PCL blend since taxol is first dissolved in MePEG before incorporation into PCL.

25

30

E. Effect of varying quantities of MePEG on taxol release

Thermopastes are made up containing between 0.8% and 20% MePEG in PCL. These are loaded with 1% taxol. The release of taxol over time from 10 mg pellets in PBS buffer at 37°C is monitored using HPLC. As is shown in Figure 18E, the amount of MePEG in the formulation does not affect the amount of taxol that is released.

35

F. Effect of varying quantities of taxol on the total amount of taxol released from a 20% MePEG/PCL blend

5 Thermopastes are made up containing 20% MePEG in PCL and loaded with between 0.2% and 10% taxol. The release of taxol over time is measured as described above. As shown in Figure 18F, the amount of taxol released over time increases with increased taxol loading. When plotted as the percent total taxol released, however, the order is reversed (Figure 18G). This
10 gives information about the residual taxol remaining in the paste and, if assumptions are made about the validity of extrapolating this data, allows for a projection of the period of time over which taxol will be released from the 20% MePEG Thermopaste.

15 G. Strength analysis of various MePEG/PCL blends

A CT-40 mechanical strength tester is used to measure the strength of solid polymer "tablets" of diameter 0.88 cm and an average thickness of 0.560 cm. The polymer tablets are blends of MePEG at concentrations of
20 0%, 5%, 10% or 20% in PCL.

Results of this test are shown in Figure 18H, where both the tensile strength and the time to failure are plotted as a function of %MePEG in the blend. Single variable ANOVA indicated that the tablet thicknesses within each group are not different. As can be seen from Figure 18H, the addition of
25 MePEG into PCL decreased the hardness of the resulting solid.

EXAMPLE 15

EFFECT OF TAXOL-LOADED THERMOPASTE ON
30 ANGIOGENESIS *IN VIVO*

Fertilized, domestic chick embryos were incubated for 4 days prior to shell-less culturing as described in Example 2. The egg contents are removed from the shell and emptied into round-bottom sterilized glass bowls
35 and covered with petri dish covers.

Taxol is incorporated into thermopaste at concentrations of 5%, 10%, and 20% (w/v) essentially as described above (see Example 10), and used

in the following experiments. Dried cut thermopaste is then heated to 60°C and pressed between two sheets of parafilm, flattening it, and allowing it to cool. Six embryos received 20% taxol-loaded thermopaste and 6 embryos received unloaded thermopaste prepared in this manner. One embryo died in each group leaving 5 embryos in each of the control and treated groups.

Unloaded thermopaste and thermopaste containing 20% taxol was also heated to 60°C and placed directly on the growing edge of each CAM at day 6 of incubation; two embryos each were treated in this manner.

There was no observable difference in the results obtained using the different methods of administration, indicating that the temperature of the paste at the time of application was not a factor in the outcome.

Thermopaste with 10% taxol was applied to 11 CAMs and unloaded thermopaste was applied to an additional 11 CAMs, while 5% taxol-loaded thermopaste was applied to 10 CAMs and unloaded thermopaste was applied to 10 other control CAMs. After a 2 day exposure (day 8 of incubation) the vasculature was examined with the aid of a stereomicroscope. Liposyn II, a white opaque solution, was injected into the CAM to increase the visibility of the vascular details.

In the embryos treated with 5% taxol-loaded paste, only 2 animals demonstrated maximum inhibition of angiogenesis, while the remaining 8 were only marginally affected. Of the animals treated with 10% taxol-loaded thermopaste only 2 showed maximal inhibition while the other 9 were only marginally affected.

The 20% taxol-loaded thermopaste showed extensive areas of avascularity (see Figure 19B) in all 5 of the CAMs receiving this treatment. The highest degree of inhibition was defined as a region of avascularity covering 6 mm by 6 mm in size. All of the CAMs treated with 20% taxol-loaded thermopaste displayed this degree of angiogenesis inhibition.

By comparison, the control (unloaded) thermopaste did not inhibit angiogenesis on the CAM (see Figure 19A); this higher magnification view (note that the edge of the paste is seen at the top of the image) demonstrates that the vessels adjacent to the paste are unaffected by the thermopaste. This suggests that the effect observed is due to the sustained release of taxol and is not due to the polymer itself or due to a secondary pressure effect of the paste on the developing vasculature.

This study demonstrates that thermopaste releases sufficient quantities of angiogenesis inhibitor (in this case taxol) to inhibit the normal development of the CAM vasculature.

5

EXAMPLE 16

EFFECT OF TAXOL-LOADED THERMOPASTE ON TUMOR GROWTH AND TUMOR ANGIOGENESIS *In Vivo*

10 Fertilized domestic chick embryos are incubated for 3 days prior to having their shells removed. The egg contents are emptied by removing the shell located around the airspace, severing the interior shell membrane, perforating the opposite end of the shell and allowing the egg contents to gently slide out from the blunted end. The contents are emptied into round-bottom
15 sterilized glass bowls, covered with petri dish covers and incubated at 90% relative humidity and 3% carbon dioxide (see Example 2).

MDAY-D2 cells (a murine lymphoid tumor) is injected into mice and allowed to grow into tumors weighing 0.5-1.0 g. The mice are sacrificed, the tumor sites wiped with alcohol, excised, placed in sterile tissue culture media,
20 and diced into 1 mm pieces under a laminar flow hood. Prior to placing the dissected tumors onto the 9-day old chick embryos, CAM surfaces are gently scraped with a 30 gauge needle to insure tumor implantation. The tumors are then placed on the CAMs after 8 days of incubation (4 days after deshelling), and allowed to grow on the CAM for four days to establish a vascular supply.
25 Four embryos are prepared utilizing this method, each embryo receiving 3 tumors. For these embryos, one tumor receives 20% taxol-loaded thermopaste, the second tumor unloaded thermopaste, and the third tumor no treatment. The treatments are continued for two days before the results were recorded.

The explanted MDAY-D2 tumors secrete angiogenic factors
30 which induce the ingrowth of capillaries (derived from the CAM) into the tumor mass and allow it to continue to grow in size. Since all the vessels of the tumor are derived from the CAM, while all the tumor cells are derived from the explant, it is possible to assess the effect of therapeutic interventions on these two processes independently. This assay has been used to determine the
35 effectiveness of taxol-loaded thermopaste on: (a) inhibiting the vascularization of the tumor and (b) inhibiting the growth of the tumor cells themselves.

Direct *in vivo* stereomicroscopic evaluation and histological examination of fixed tissues from this study demonstrated the following. In the tumors treated with 20% taxol-loaded thermopaste, there was a reduction in the number of the blood vessels which supplied the tumor (see Figures 20C and 20D), a reduction in the number of blood vessels within the tumor, and a reduction in the number of blood vessels in the periphery of the tumor (the area which is typically the most highly vascularized in a solid tumor) when compared to control tumors. The tumors began to decrease in size and mass during the two days the study was conducted. Additionally, numerous endothelial cells were seen to be arrested in cell division indicating that endothelial cell proliferation had been affected. Tumor cells were also frequently seen arrested in mitosis. All 4 embryos showed a consistent pattern with the 20% taxol-loaded thermopaste suppressing tumor vascularity while the unloaded thermopaste had no effect.

By comparison, in CAMs treated with unloaded thermopaste, the tumors were well vascularized with an increase in the number and density of vessels when compared to that of the normal surrounding tissue, and dramatically more vessels than were observed in the tumors treated with taxol-loaded paste. The newly formed vessels entered the tumor from all angles appearing like spokes attached to the center of a wheel (see Figures 20A and 20B). The control tumors continued to increase in size and mass during the course of the study. Histologically, numerous dilated thin-walled capillaries were seen in the periphery of the tumor and few endothelial were seen to be in cell division. The tumor tissue was well vascularized and viable throughout.

As an example, in two similarly-sized (initially, at the time of explantation) tumors placed on the same CAM the following data was obtained. For the tumor treated with 20% taxol-loaded thermopaste the tumor measured 330 mm x 597 mm; the immediate periphery of the tumor has 14 blood vessels, while the tumor mass has only 3-4 small capillaries. For the tumor treated with unloaded thermopaste the tumor size was 623 mm x 678 mm; the immediate periphery of the tumor has 54 blood vessels, while the tumor mass has 12-14 small blood vessels. In addition, the surrounding CAM itself contained many more blood vessels as compared to the area surrounding the taxol-treated tumor.

This study demonstrates that thermopaste releases sufficient quantities of angiogenesis inhibitor (in this case taxol) to inhibit the pathological angiogenesis which accompanies tumor growth and development. Under these

conditions angiogenesis is maximally stimulated by the tumor cells which produce angiogenic factors capable of inducing the ingrowth of capillaries from the surrounding tissue into the tumor mass. The 20% taxol-loaded thermopaste is capable of blocking this process and limiting the ability of the tumor tissue to maintain an adequate blood supply. This results in a decrease in the tumor mass both through a cytotoxic effect of the drug on the tumor cells themselves and by depriving the tissue of the nutrients required for growth and expansion.

10

EXAMPLE 17

EFFECT OF ANGIOGENESIS INHIBITOR-LOADED THERMOPASTE ON TUMOR GROWTH *In Vivo* IN A MURINE TUMOR MODEL

The murine MDAY-D2 tumor model may be used to examine the effect of local slow release of the chemotherapeutic and anti-angiogenic compounds such as taxol on tumor growth, tumor metastasis, and animal survival. The MDAY-D2 tumor cell line is grown in a cell suspension consisting of 5% Fetal Calf Serum in alpha mem media. The cells are incubated at 37°C in a humidified atmosphere supplemented with 5% carbon dioxide, and are diluted by a factor of 15 every 3 days until a sufficient number of cells are obtained. Following the incubation period the cells are examined by light microscopy for viability and then are centrifuged at 1500 rpm for 5 minutes. PBS is added to the cells to achieve a dilution of 1,000,000 cells per ml.

Ten week old DBA/2j female mice are acclimatized for 3-4 days after arrival. Each mouse is then injected subcutaneously in the posteriolateral flank with 100,000 MDAY-D2 cells in 100 ml of PBS. Previous studies have shown that this procedure produces a visible tumor at the injection site in 3-4 days, reach a size of 1.0-1.7g by 14 days, and produces visible metastases in the liver 19-25 days post-injection. Depending upon the objective of the study a therapeutic intervention can be instituted at any point in the progression of the disease.

Using the above animal model, 20 mice are injected with 140,000 MDAY-D2 cells s.c. and the tumors allowed to grow. On day 5 the mice are divided into groups of 5. The tumor site was surgically opened under anesthesia, the local region treated with the drug-loaded thermopaste or control thermopaste without disturbing the existing tumor tissue, and the wound was closed. The groups of 5 received either no treatment (wound merely closed),

polymer (PCL) alone, 10% taxol-loaded thermopaste, or 20% taxol-loaded thermopaste (only 4 animals injected) implanted adjacent to the tumor site. On day 16, the mice were sacrificed, the tumors were dissected and examined (grossly and histologically) for tumor growth, tumor metastasis, local and systemic toxicity resulting from the treatment, effect on wound healing, effect on tumor vascularity, and condition of the paste remaining at the incision site.

The weights of the tumors for each animal is shown in the table below:

10

Table IV
Tumor Weights (gm)

Animal No.	Control (empty)	Control (PCL)	10% Taxol Thermopaste	20% Taxol Thermopaste
1	1.387	1.137	0.487	0.114
2	0.589	0.763	0.589	0.192
3	0.461	0.525	0.447	0.071
4	0.606	0.282	0.274	0.042
5	0.353	0.277	0.362	
Mean	0.6808	0.6040	0.4318	0.1048
Std. Deviation	0.4078	0.3761	0.1202	0.0653
P Value		0.7647	0.358	0.036

25

Thermopaste loaded with 20% taxol reduced tumor growth by over 85% (average weight 0.105) as compared to control animals (average weight 0.681). Animals treated with thermopaste alone or thermopaste containing 10% taxol had only modest effects on tumor growth; tumor weights were reduced by only 10% and 35% respectively (Figure 21A). Therefore, thermopaste containing 20% taxol was more effective in reducing tumor growth than thermopaste containing 10% taxol (see Figure 21C; see also Figure 21B).

Thermopaste was detected in some of the animals at the site of administration. Polymer varying in weight between 0.026 g to 0.078 g was detected in 8 of 15 mice. Every animal in the group containing 20% taxol-loaded thermopaste contained some residual polymer suggesting that it was less susceptible to dissolution. Histologically, the tumors treated with taxol-loaded

35

thermopaste contained lower cellularity and more tissue necrosis than control tumors. The vasculature was reduced and endothelial cells were frequently seen to be arrested in cell division. The taxol-loaded thermopaste did not appear to affect the integrity or cellularity of the skin or tissues surrounding the tumor.
5 Grossly, wound healing was unaffected.

EXAMPLE 18

10 THE USE OF ANGIOGENESIS-INHIBITOR LOADED SURGICAL FILMS IN THE PREVENTION OF IATROGENIC METASTATIC SEEDING OF TUMOR CELLS DURING CANCER RESECTION SURGERY

As a sterile, pliable, stretchable drug-polymer compound would be useful during cancer resection procedures. Often it is desirable to isolate the
15 normal surrounding tissues from malignant tissue during resection operations to prevent iatrogenic spread of the disease to adjacent organs through inadvertent contamination by cancer cells. A drug-loaded parafilm could be stretched across normal tissues prior to manipulation of the tumor. This would be most useful if placed around the liver and other abdominal contents during bowel
20 cancer resection surgery to prevent intraperitoneal spread of the disease to the liver. A biodegradable film could be left *in situ* to provide continued protection.

Incision sites are also a common location of post-operative recurrence of malignancy. This is thought to be due to contamination of the wound site with tumor cells during the surgical procedure. To address these
25 issues, experiments are being conducted to determine the ability of angiogenesis inhibitor-loaded films to prevent this phenomenon.

A. Materials and Methods

30 Preparation of Surgical Film. Surgical films are prepared as described in Example 10. Thin films measuring approximately 1 cm x 1 cm are prepared containing either polymer alone (PCL) or PCL loaded with 5% taxol.

35 Rat Hepatic Tumor Model. In an initial study Wistar rats weighing approximately 300 g underwent general anesthesia and a 3-5 cm abdominal incision is made along the midline. In the largest hepatic lobe, a 1 cm incision is made in the hepatic parenchyma and part of the liver edge is resected. A

concentration of 1 million live 9L Glioma tumor cells (eluted from tissue culture immediately prior to the procedure) suspended in 100 ml of phosphate buffered saline are deposited onto the cut liver edge with a 30 gauge needle. The surgical is then placed over the cut liver edge containing the tumor cells and
5 affixed in place with Gelfoam. Two animals received PCL films containing 5% taxol and two animals received films containing PCL alone. The abdominal wall is closed with 3.0 Dexon and skin clips. The general anesthetic is terminated and the animal is allowed to recover. Ten days later the animals are sacrificed and the livers examined histologically.

10

B. Results

Local tumour growth is seen in the 2 livers treated with polymer alone. Both livers treated with polymer plus taxol are completely free of tumour
15 when examined histologically. Also of importance, the liver capsule had regenerated and grown completely over the polymeric film and the cut surface of the liver indicating that there is no significant effect on wound healing. There is no evidence of local hepatic toxicity surrounding any (drug-loaded or drug-free) of the surgical films.

20

C. Discussion

This study indicates that surgical films placed around normal tissues and incision sites during surgery may be capable of decreasing the
25 incidence of accidental implantation of tumor cells into normal surrounding tissue during resection of malignant tumors. This may help reduce the incidence of the significant problem of post-operative local recurrence of the disease.

30

EXAMPLE 19

INTRA-ARTICULAR INJECTION OF ANGIOGENESIS-INHIBITOR-LOADED BIODEGRADABLE MICROSPHERES IN THE TREATMENT OF ARTHRITIS

35

Articular damage in arthritis is due to a combination of inflammation (including WBCs and WBC products) and pannus tissue development (a tissue composed on neovascular tissue, connective tissue, and inflammatory cells). Taxol has been chosen for the initial studies because it is a

potent inhibitor of neovascularization. In this manner, taxol in high local concentrations will prove to be a disease modifying agent in arthritis.

In order to determine whether microspheres have a deleterious effect on joints, the following experiments are conducted. Briefly, plain PCL
5 and taxol-loaded microspheres are prepared as described previously in Example 8.

Three rabbits are injected intra-articularly with 0.5-5.0 μm , 10-30
 μm , or 30-80 μm microspheres in a total volume of 0.2 mls (containing 0.5 mg of
microspheres). The joints are assessed visually (clinically) on a daily basis.
10 After two weeks the animals are sacrificed and the joints examined
histologically for evidence of inflammation and depletion of proteoglycans.

The rabbit inflammatory arthritis and osteoarthritis models are
being used to evaluate the use of microspheres in reducing synovitis and
cartilage degradation. Degenerative arthritis is induced by a partial tear of the
15 cruciate ligament and meniscus of the knee. After 4 to 6 weeks, the rabbits
develop erosions in the cartilage similar to that observed in human
osteoarthritis. Inflammatory arthritis is induced by immunizing rabbits with
bovine serum albumen (BSA) in Complete Freund's Adjuvant (CFA). After 3
weeks, rabbits containing a high titer of anti-BSA antibody receive an intra-
20 articular injection of BSA (5 mg). Joint swelling and pronounced synovitis is
apparent by seven days, a proteoglycan depletion is observed by 7 to 14 days,
and cartilage erosions are observed by 4 to 6 weeks.

Inflammatory arthritis is induced as described above. After 4
days, the joints are injected with microspheres containing 5% taxol or vehicle.
25 One group of animals will be sacrificed on day 14 and another on day 28. The
joints are examined histologically for inflammation and cartilage degradation.
The experiment is designed to determine if taxol microspheres can affect joint
inflammation and cartilage matrix degradation.

Angiogenesis-inhibitor microspheres may be further examined in
30 an osteoarthritis model. Briefly, degenerative arthritis is induced in rabbits as
described above, and the joints receive an intra-articular injection of
microspheres (5% taxol or vehicle only) on day 4. The animals are sacrificed on
day 21 and day 42 and the joints examined histologically for evidence of
cartilage degradation.

35 Studies are conducted to assess angiogenesis inhibitors delivered
via intra-articular microspheres as chondroprotective agents.

Results

Unloaded PCL microspheres of differing sizes (0.5-5.0 μm , 10-30 μm , or 30-80 μm) were injected intra-articularly into the rabbit knee joint. 5 Results of these experiments are shown in Figures 22A to D. Briefly, Figure 22A is a photograph of synovium from PBS injected joints. Figure 22B is a photograph of joints injected with microspheres. Figure 22C is a photograph of cartilage from joints injected with PBS, and Figure 22D is a photograph of cartilage from joints injected with microspheres.

10 As can be seen from these photographs, histologically, there is no difference between joints receiving a microsphere injection and those which did not. Clinically, there was no evidence of joint inflammation during the 14 days the experiment was conducted. Grossly, there is no evidence of joint inflammation or cartilage damage in joints where microspheres are injected, as 15 compared to untreated normal joints.

Conclusions

20 Microspheres can be injected intra-articularly without causing any discernible changes to the joint surface. This indicates that this method may be an effective means of delivering a targeted, sustained-release of disease-modifying agents to diseased joints, while minimizing the toxicity which could be associated with the systemic administration of such biologically active compounds.

25 As discussed above, microspheres can be formulated into specific sizes with defined drug release kinetics. It has also been demonstrated that taxol is a potent inhibitor of angiogenesis and that it is released from microspheres in quantities sufficient to block neovascularization on the CAM assay. Therefore, intra-articular administration of angiogenesis-inhibitor-loaded 30 (e.g., taxol-loaded) microspheres should be capable of blocking the neovascularization that occurs in diseases such as rheumatoid arthritis and leads to cartilage destruction in the joint. In this manner the drug-loaded microspheres can act as a "chondroprotective" agent which protects the cartilage from irreversible destruction from invading neovascular pannus tissue.

35

From the foregoing, it will be appreciated that, although specific embodiments of the invention have been described herein for purposes of

illustration, various modifications may be made without deviating from the spirit and scope of the invention. Accordingly, the invention is not limited except as by the appended claims.

SEQUENCE LISTING

(1) GENERAL INFORMATION:

(i) APPLICANT: Hunter, William L.
Machan, Lindsay S.
Arsenault, A. Larry
Burt, Helen M.

(ii) TITLE OF INVENTION: Anti-Angiogenic Compositions and Methods of Use

(iii) NUMBER OF SEQUENCES: 1

(iv) CORRESPONDENCE ADDRESS:

(A) ADDRESSEE: SEED and BERRY
(B) STREET: 701 Fifth Avenue, 6300 Columbia Center
(C) CITY: Seattle
(D) STATE: Washington
(E) COUNTRY: USA
(F) ZIP: 98104

(v) COMPUTER READABLE FORM:

(A) MEDIUM TYPE: Floppy disk
(B) COMPUTER: IBM PC compatible
(C) OPERATING SYSTEM: PC-DOS/MS-DOS
(D) SOFTWARE: PatentIn Release #1.0, Version #1.25

(vi) CURRENT APPLICATION DATA:

(A) APPLICATION NUMBER:
(B) FILING DATE:
(C) CLASSIFICATION:

(viii) ATTORNEY/AGENT INFORMATION:

(A) NAME: McMasters, David D.
(B) REGISTRATION NUMBER: 33,963
(C) REFERENCE/DOCKET NUMBER: 110129.401

(ix) TELECOMMUNICATION INFORMATION:

(A) TELEPHONE: (206) 622-4900

(B) TELEFAX: (206) 682-6031

(C) TELEX: 3723836

(2) INFORMATION FOR SEQ ID NO:1:

(i) SEQUENCE CHARACTERISTICS:

(A) LENGTH: 9 amino acids

(B) TYPE: amino acid

(C) STRANDEDNESS: single

(D) TOPOLOGY: linear

(ii) MOLECULE TYPE: peptide

(v) FRAGMENT TYPE: N-terminal

(xi) SEQUENCE DESCRIPTION: SEQ ID NO:1:

Cys Asp Pro Gly Tyr Ile Gly Ser Arg

1

5

Claims

1. A composition, comprising:
 - (a) an anti-angiogenic factor; and
 - (b) a polymeric carrier.
2. The composition of claim 1 wherein said anti-angiogenic factor is Anti-Invasive Factor.
3. The composition of claim 1 wherein said anti-angiogenic factor is retinoic acid and derivatives thereof.
4. The composition of claim 1 wherein said anti-angiogenic factor is selected from the group consisting of Suramin, Tissue Inhibitor of Metalloproteinase-1, Tissue Inhibitor of Metalloproteinase-2, Plasminogen Activator Inhibitor-1 and Plasminogen Activator Inhibitor-2.
5. A composition, comprising:
 - (a) taxol; and
 - (b) a polymeric carrier.
6. The composition according to any one of claims 1 to 5 wherein said composition is formed into microspheres having an average size of between 0.1 and 200 μm .
7. The composition according to any one of claims 1 to 5 wherein said composition is formed into a film with a thickness of between 100 μm and 2 mm.
8. The composition according to any one of claims 1 to 5 wherein said composition is liquid above 45°C, and solid or semi-solid at 37°C.
9. The composition according to any one of claim 1 to 5 wherein said polymeric carrier is poly(ethylene-vinyl acetate) crosslinked with 40% vinyl acetate.
10. The composition according to any one of claim 1 to 5 wherein said polymeric carrier is poly(lactic-co-glycolic acid).

11. The composition according to any one of claim 1 to 5 wherein said polymeric carrier is polycaprolactone.

12. The composition according to any one of claim 1 to 5 wherein said polymeric carrier is polylactic acid.

13. The composition according to any one of claim 1 to 5 wherein said polymeric carrier is a copolymer of poly(ethylene-vinyl acetate) crosslinked with 40% vinyl acetate, and polylactic acid.

14. The composition according to any one of claim 1 to 5 wherein said polymeric carrier is a copolymer of polylactic acid and polycaprolactone.

15. A method for embolizing a blood vessel, comprising delivering into said vessel a therapeutically effective amount of composition according to any one of claims 1-14, such that said blood vessel is effectively occluded.

16. The method claim 13 wherein said blood vessel nourishes a tumor.

17. A stent, comprising a generally tubular structure, the surface of which is coated with a composition according to any one of claims 1-14.

18. A method for expanding the lumen of a body passageway, comprising inserting a stent into the passageway, the stent having a generally tubular structure, the surface of said structure being coated with a composition according to any one of claims 1-14, such that said passageway is expanded.

19. A method for eliminating vascular obstructions, comprising inserting a vascular stent into a vascular passageway, the stent having a generally tubular structure, the surface of said structure being coated with a composition according to any one of claims 1-14, such that said vascular obstruction is eliminated.

20. A method for eliminating biliary obstructions, comprising inserting a biliary stent into a biliary passageway, the stent having a generally tubular

structure, the surface of said structure being coated with a composition according to any one of claims 1-14, such that said biliary obstruction is eliminated.

21. A method for eliminating urethral obstructions, comprising inserting a urethral stent into a urethra, the stent having a generally tubular structure, the surface of said structure being coated with a composition according to any one of claims 1-14, such that said urethral obstruction is eliminated.

22. A method for eliminating esophageal obstructions, comprising inserting an esophageal stent into an esophagus, the stent having a generally tubular structure, the surface of said structure being coated with a composition according to any one of claims 1-14, such that said esophageal obstruction is eliminated.

23. A method for eliminating tracheal/bronchial obstructions, comprising inserting a tracheal/bronchial stent into the trachea or bronchi, the stent having a generally tubular structure, the surface of which is coated with a composition according to any one of claims 1-14, such that said tracheal/bronchial obstruction is eliminated.

24. A method for treating a tumor excision site, comprising administering a composition according to any one of claims 1-14 to the resection margin of a tumor subsequent to excision, such that the local recurrence of cancer and the formation of new blood vessels at said site is inhibited.

25. The method according to claim 24 wherein said anti-angiogenic composition is a thermopaste.

26. The method according to claim 24 wherein the step of administering comprising spraying a composition of nanospheres comprised of an anti-angiogenic composition into the resection margin of the tumor.

27. A method for treating corneal neovascularization, comprising administering a therapeutically effective amount of a composition according to any one of claims 1-14 to the cornea, such that the formation of blood vessels is inhibited.

28. The method of claim 23 wherein said composition further comprises a topical corticosteroid.

29. A method for inhibiting angiogenesis in patients with non-tumorigenic, angiogenesis-dependent diseases, comprising administering a therapeutically effective amount of a composition comprising taxol to a patient with a non-tumorigenic angiogenesis-dependent disease, such that the formation of new blood vessels is inhibited.

30. A method for embolizing a blood vessel in a non-tumorigenic, angiogenesis-dependent diseases, comprising delivering to said vessel a therapeutically effective amount of a composition comprising taxol, such that said blood vessel is effectively occluded.

31. A method for expanding the lumen of a body passageway, comprising inserting a stent into the passageway, the stent having a generally tubular structure, the surface of said structure being coated with a composition comprising taxol, such that said passageway is expanded.

32. A method for eliminating vascular obstructions, comprising inserting a vascular stent into a vascular passageway, the stent having a generally tubular structure, the surface of said structure being coated with a composition comprising taxol, such that said vascular obstruction is eliminated.

33. A method for eliminating biliary obstructions, comprising inserting a biliary stent into a biliary passageway, the stent having a generally tubular structure, the surface of said structure being coated with a composition comprising taxol, such that said biliary obstruction is eliminated.

34. A method for eliminating urethral obstructions, comprising inserting a urethral stent into a urethra, the stent having a generally tubular structure, the surface of said structure being coated with a composition comprising taxol, such that said urethral obstruction is eliminated.

35. A method for eliminating esophageal obstructions, comprising inserting an esophageal stent into an esophagus, the stent having a generally tubular structure, the surface of said structure being coated with a composition comprising taxol, such that said esophageal obstruction is eliminated.

36. A method for eliminating tracheal/bronchial obstructions, comprising inserting a tracheal/bronchial stent into the trachea or bronchi, the stent having a generally tubular structure, the surface of said structure being coated with a composition comprising taxol, such that said tracheal/bronchial obstruction is eliminated.

37. A method for treating a tumor excision site, comprising administering a composition comprising taxol to the resection margin of a tumor subsequent to excision, such that the local recurrence of cancer and the formation of new blood vessels at said site is inhibited.

38. A method for treating corneal neovascularization, comprising administering a therapeutically effective amount of a composition comprising taxol to the cornea, such that the formation of new vessels is inhibited.

39. A pharmaceutical product, comprising:

- (a) taxol, in a container; and
- (b) a notice associated with said container in form prescribed by a governmental agency regulating the manufacture, use, or sale of pharmaceuticals, which notice is reflective of approval by said agency of said taxol, for human or veterinary administration to treat non-tumorigenic angiogenesis-dependent diseases.

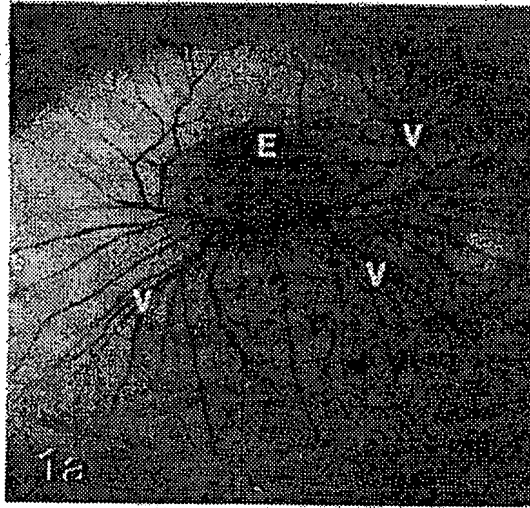

FIG. 1A



FIG. 1B

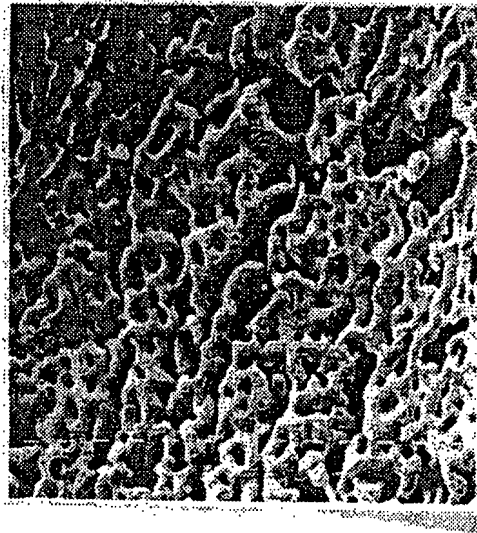
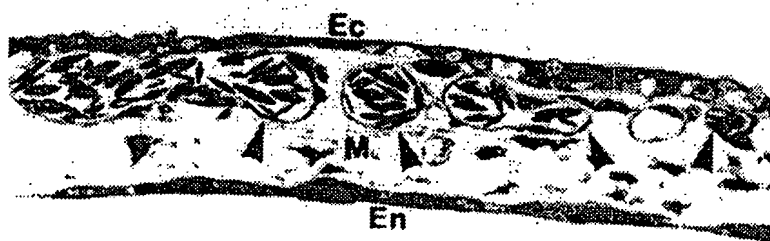

FIG. 1C

FIG. 1D



d

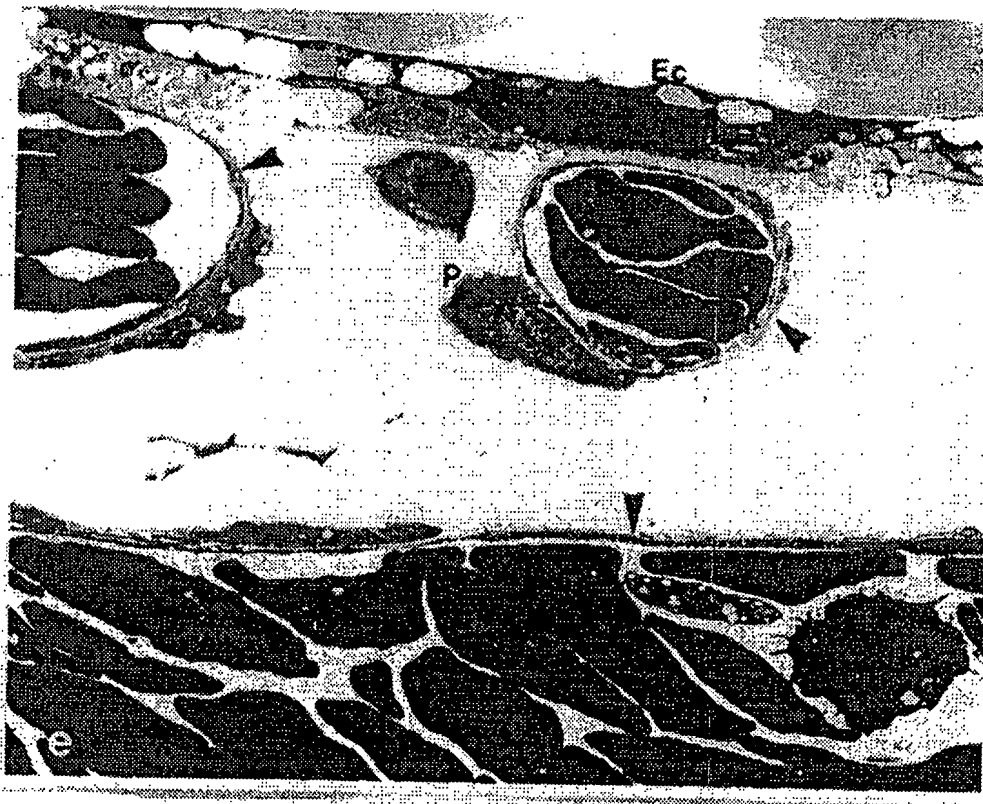

FIG. 1E



FIG. 2A



FIG. 2B

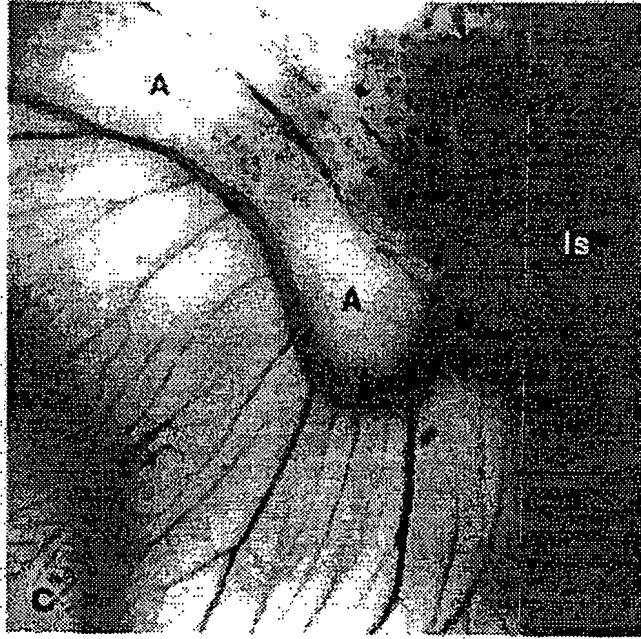

FIG. 2C

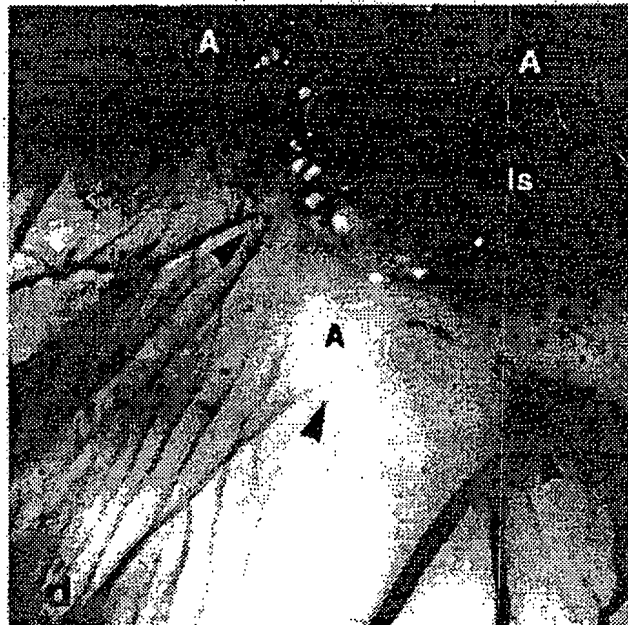

FIG. 2D

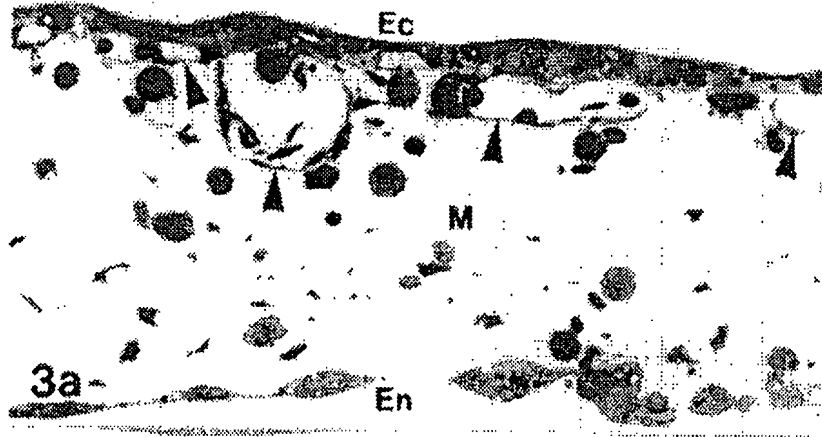

FIG. 3A



FIG. 3B

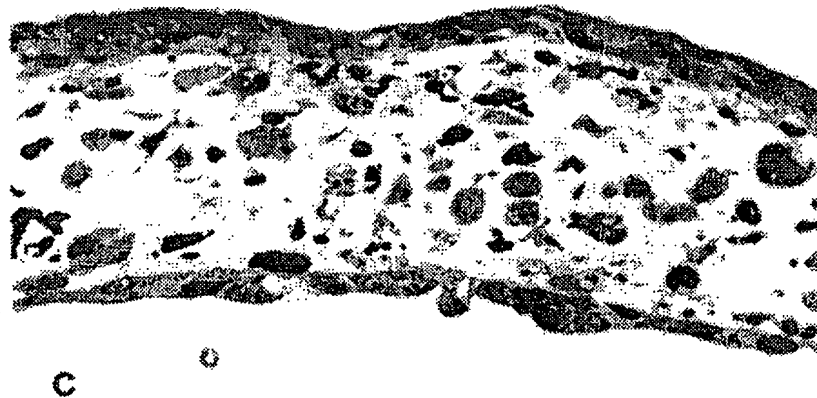

FIG. 3C

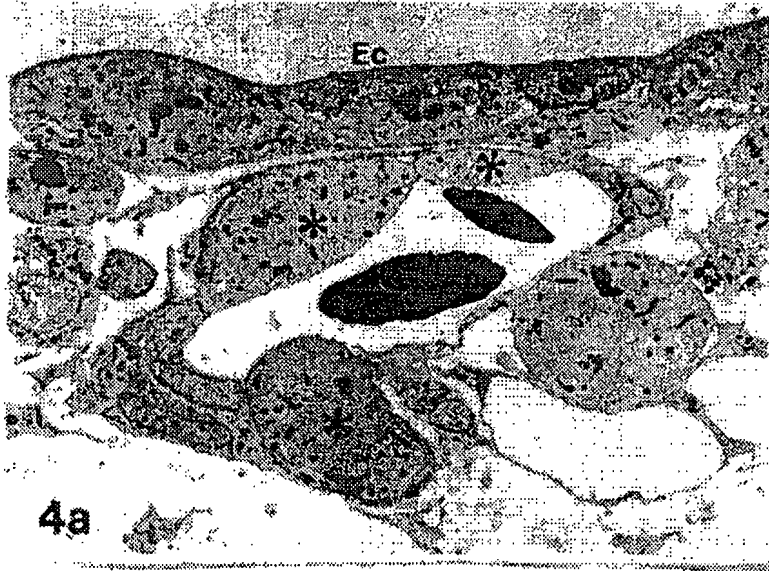

FIG. 4A

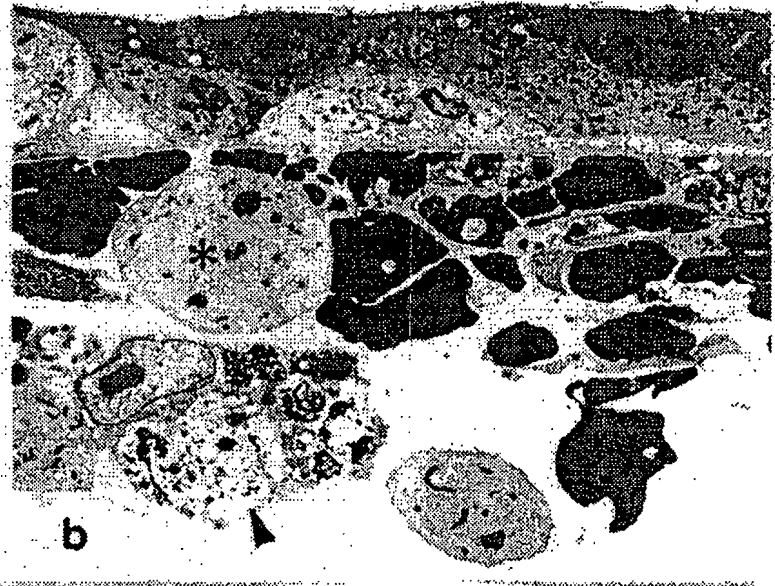

FIG. 4B



FIG. 4C

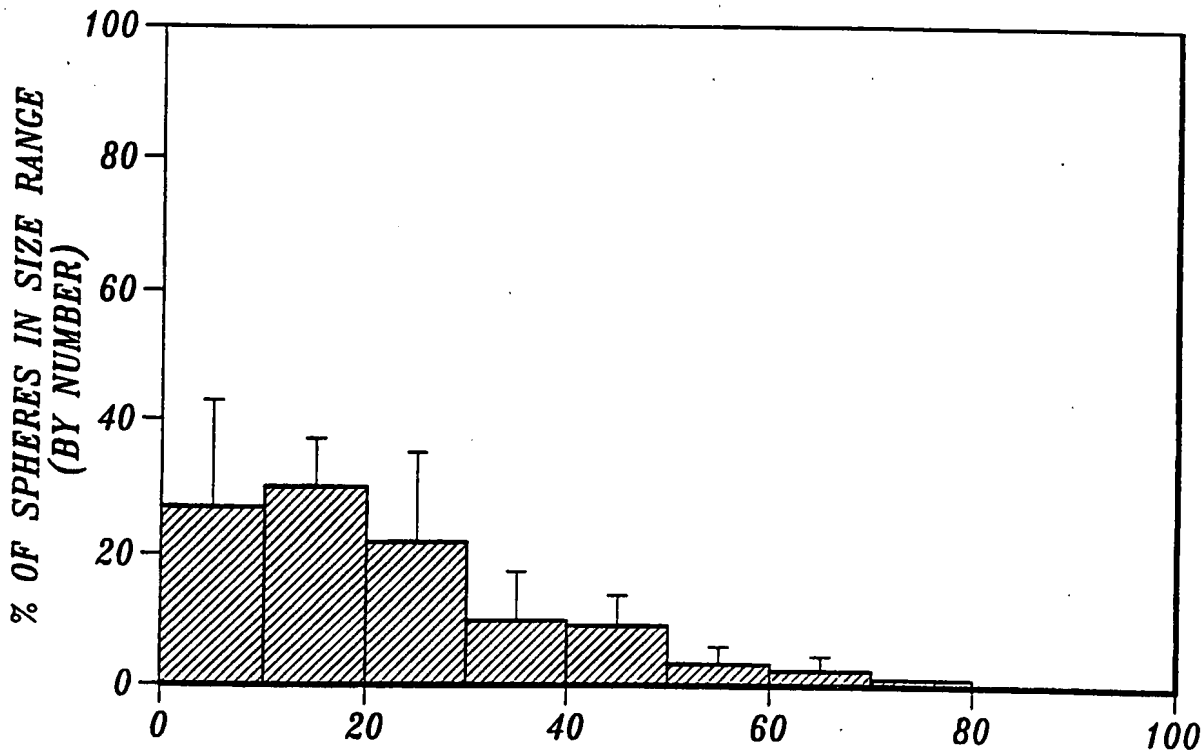

FIG. 5. SIZE RANGE (μM DIAMETER)

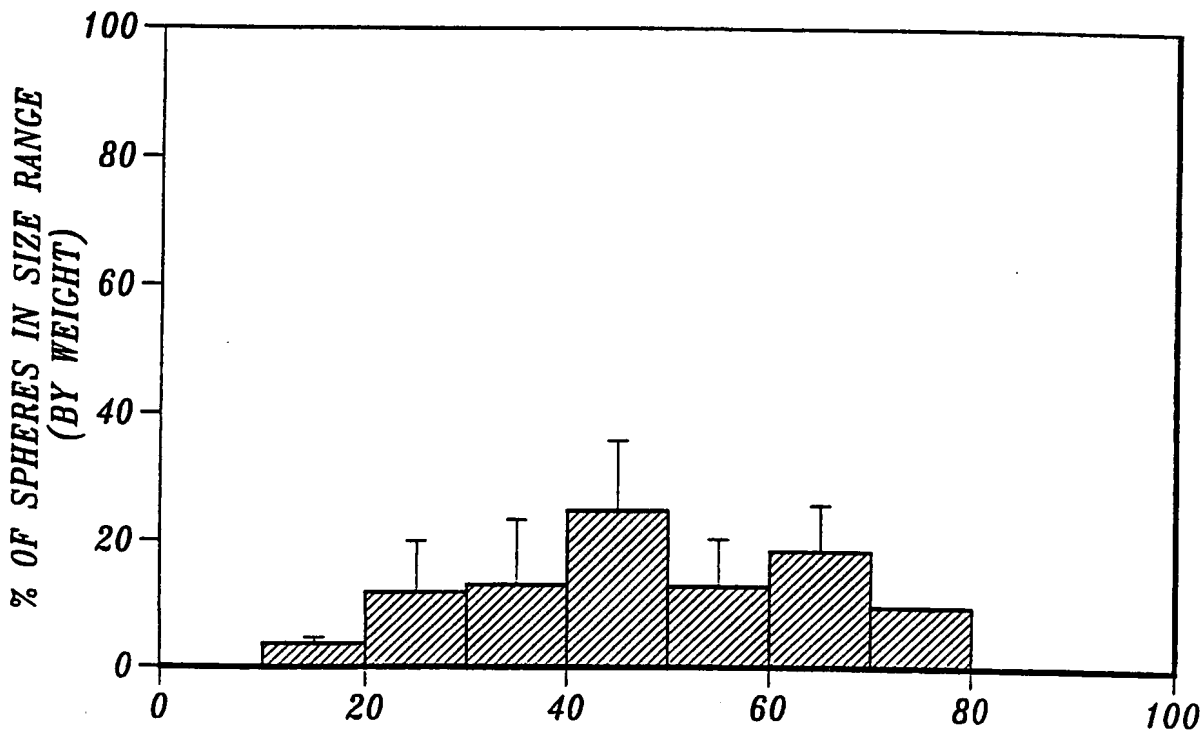

FIG. 6. SIZE RANGE (μM DIAMETER)

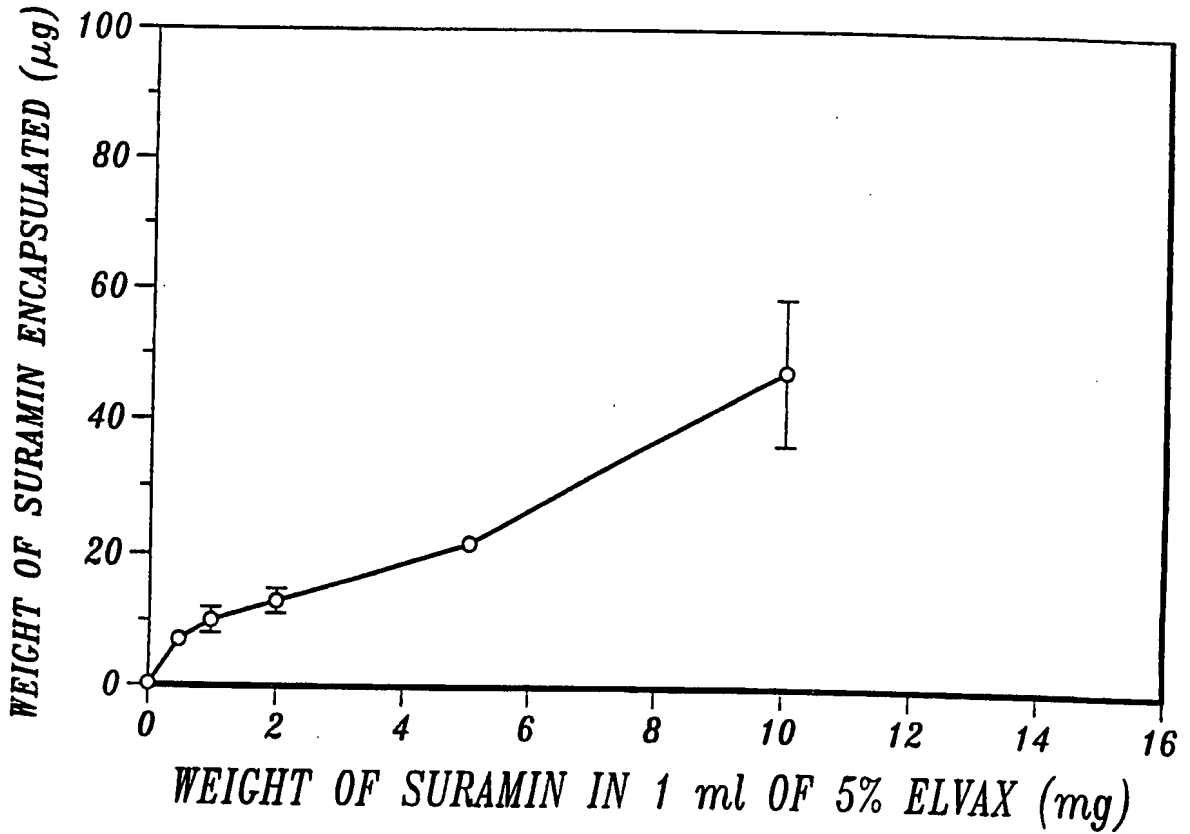

FIG. 7.

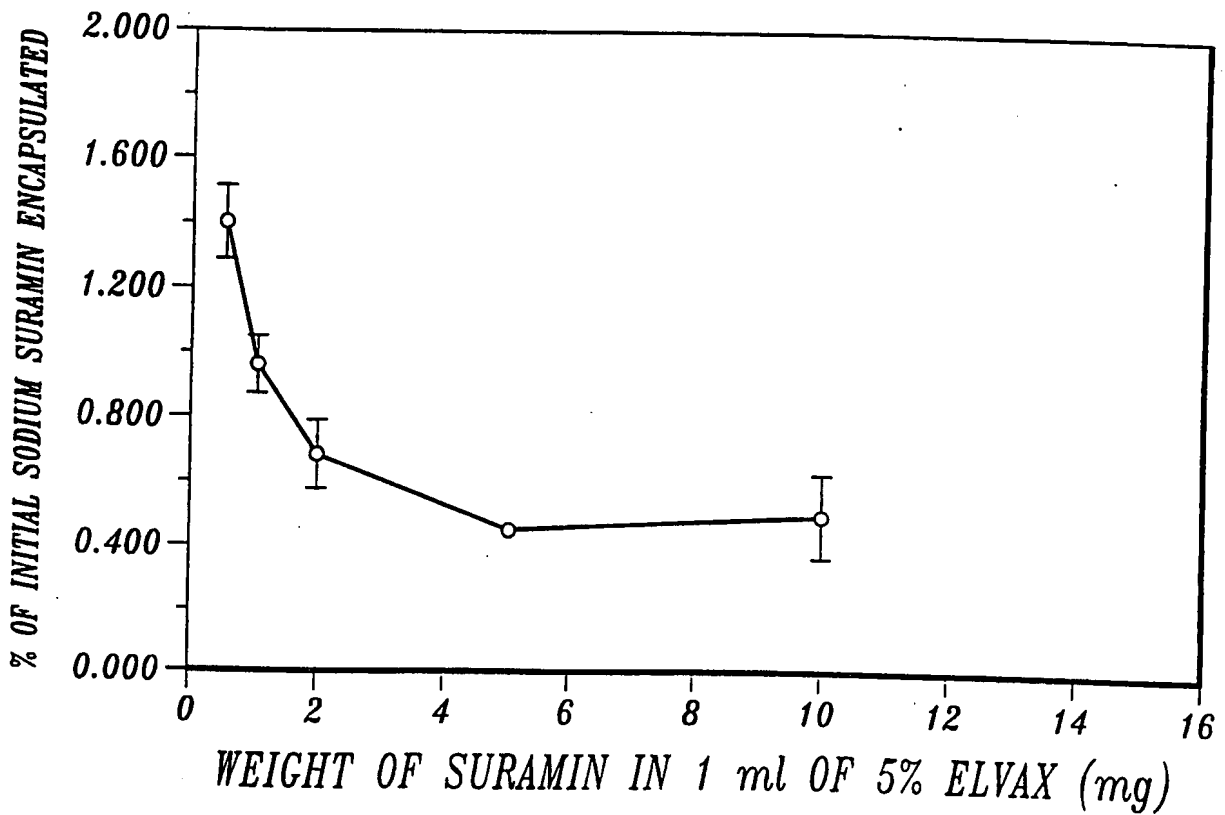

FIG. 8.

SUBSTITUTE SHEET

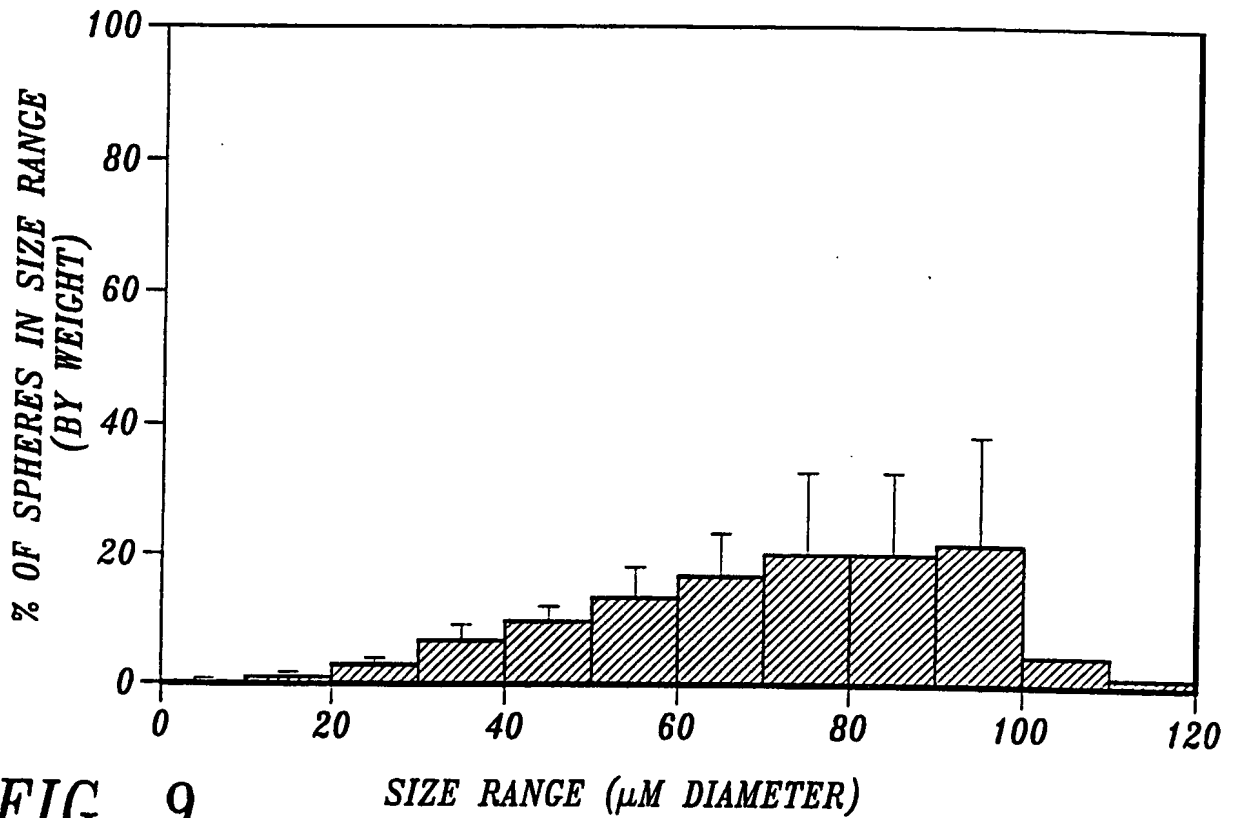

FIG. 9.

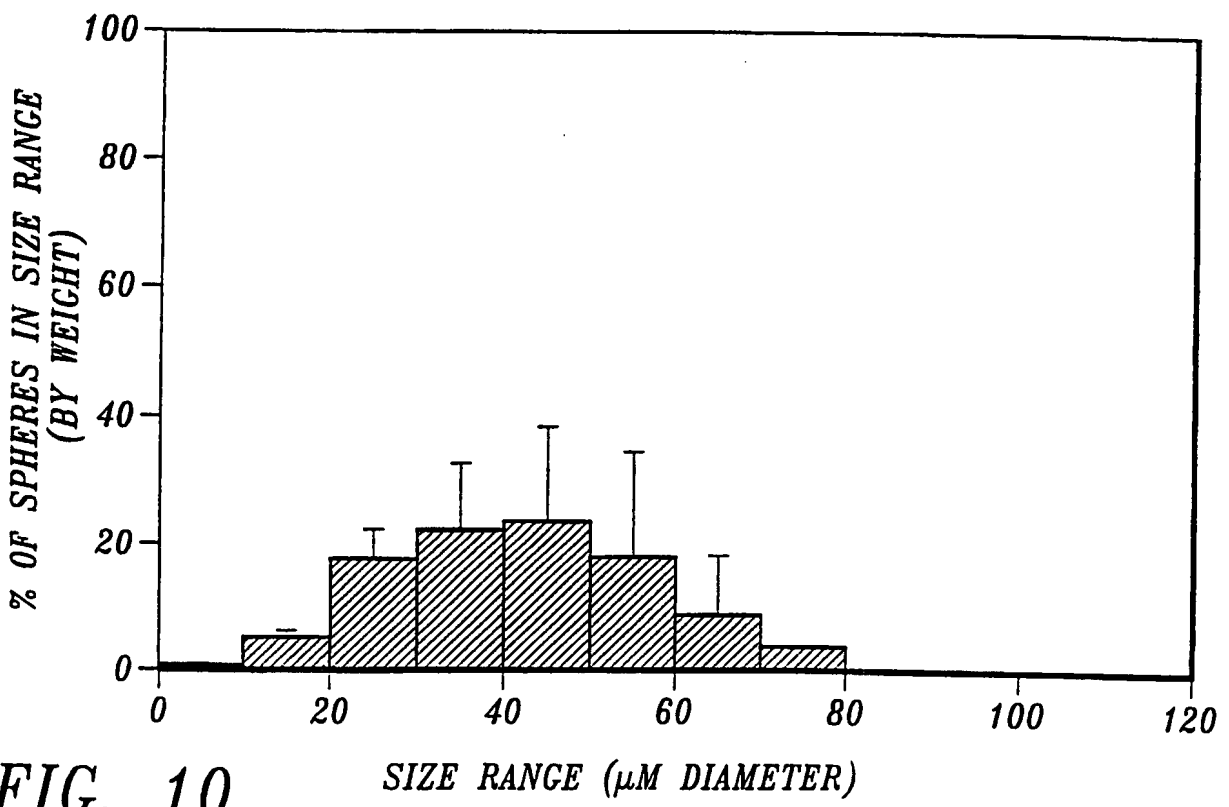

FIG. 10.

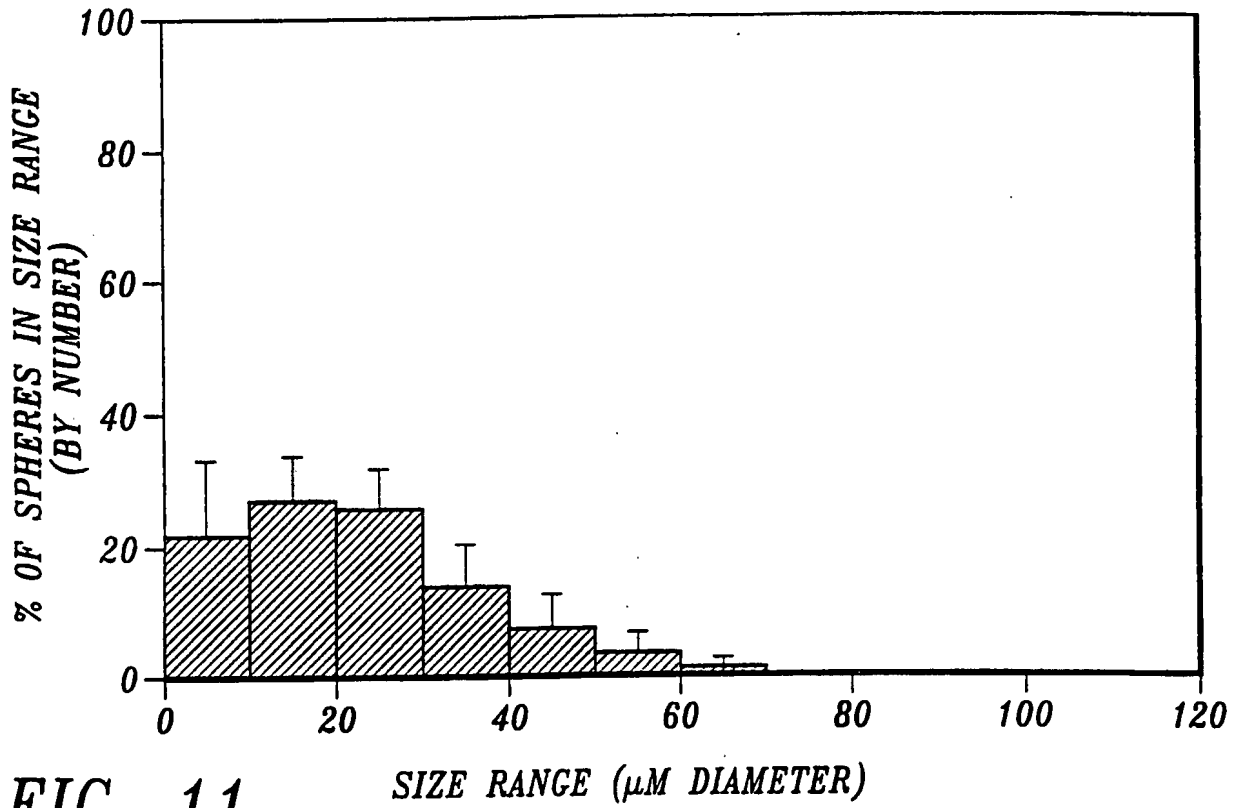

FIG. 11.

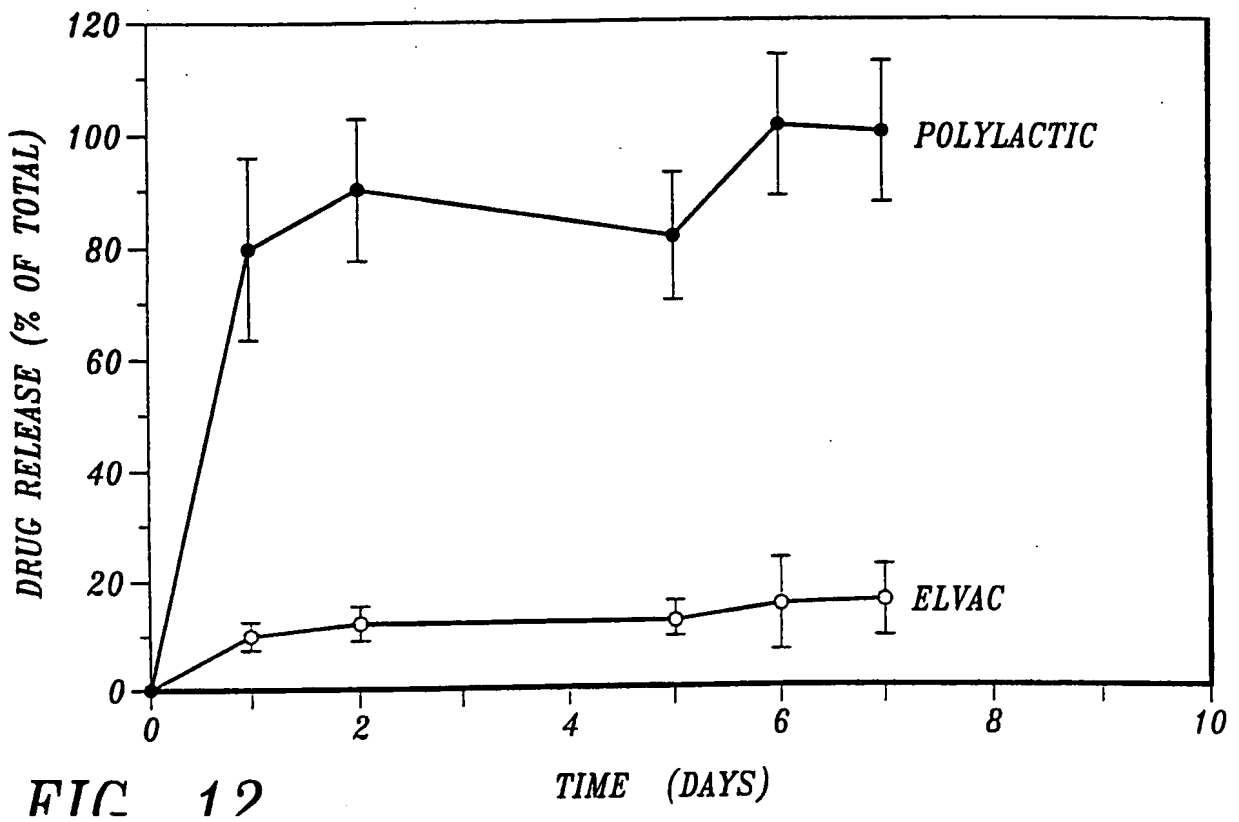

FIG 12

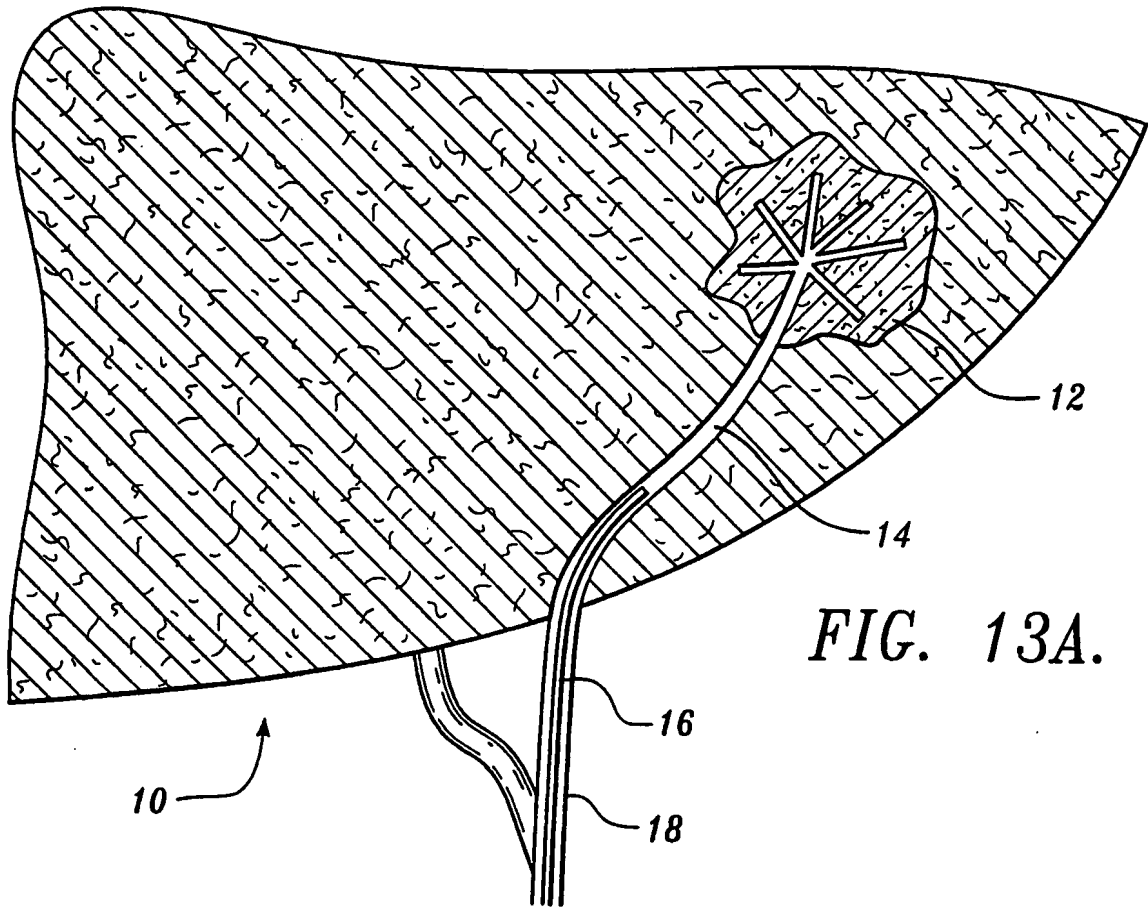
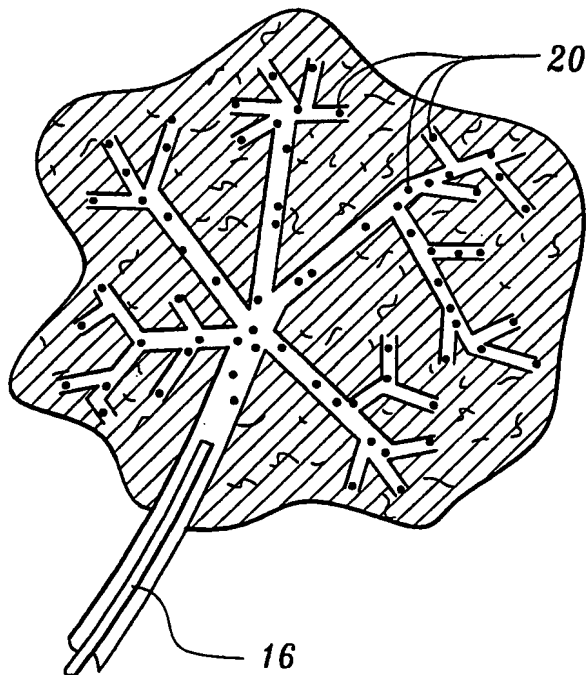
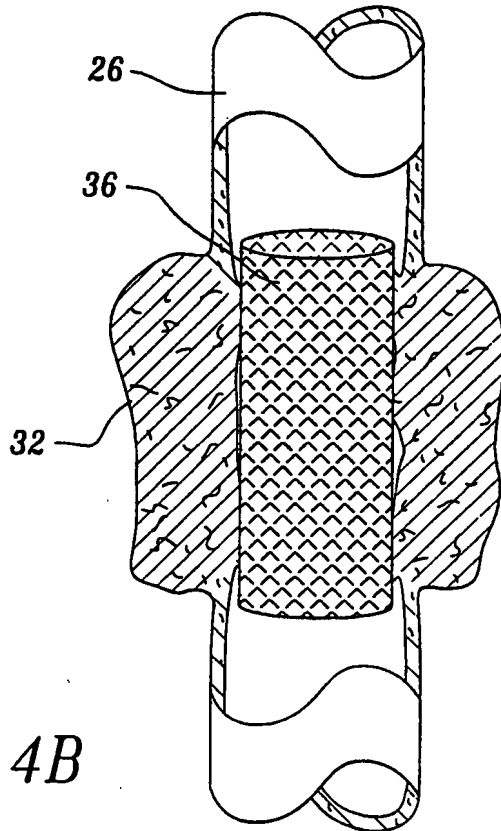
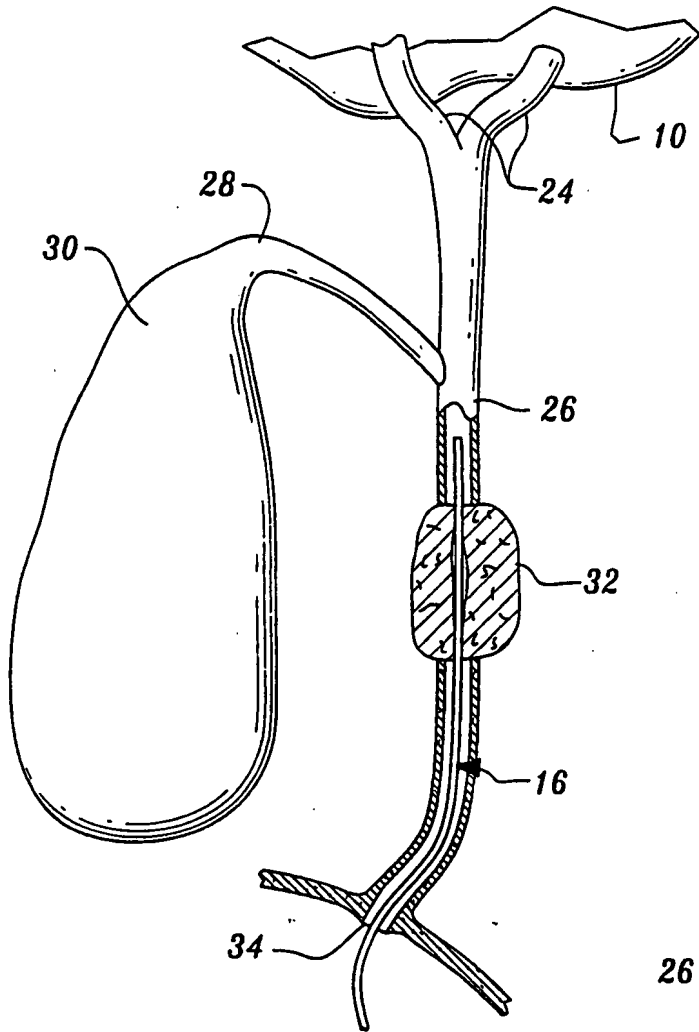

FIG. 13B.





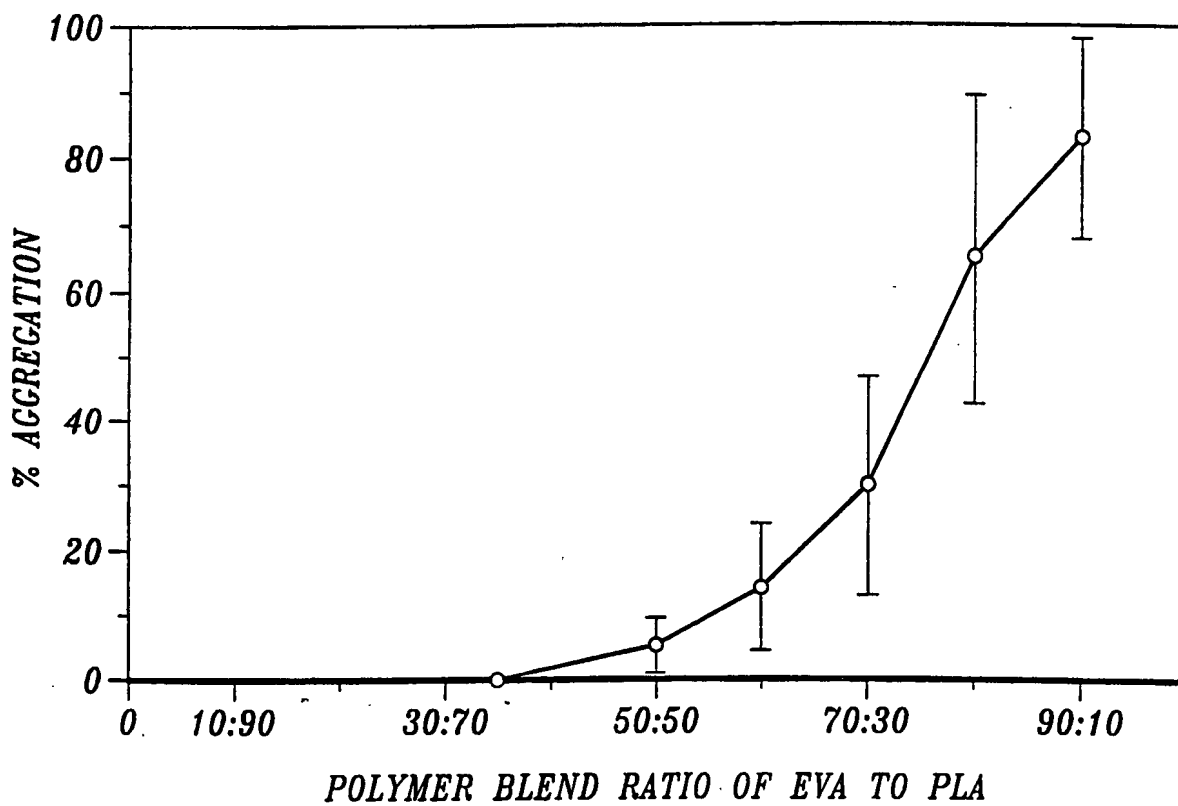

FIG. 15A.

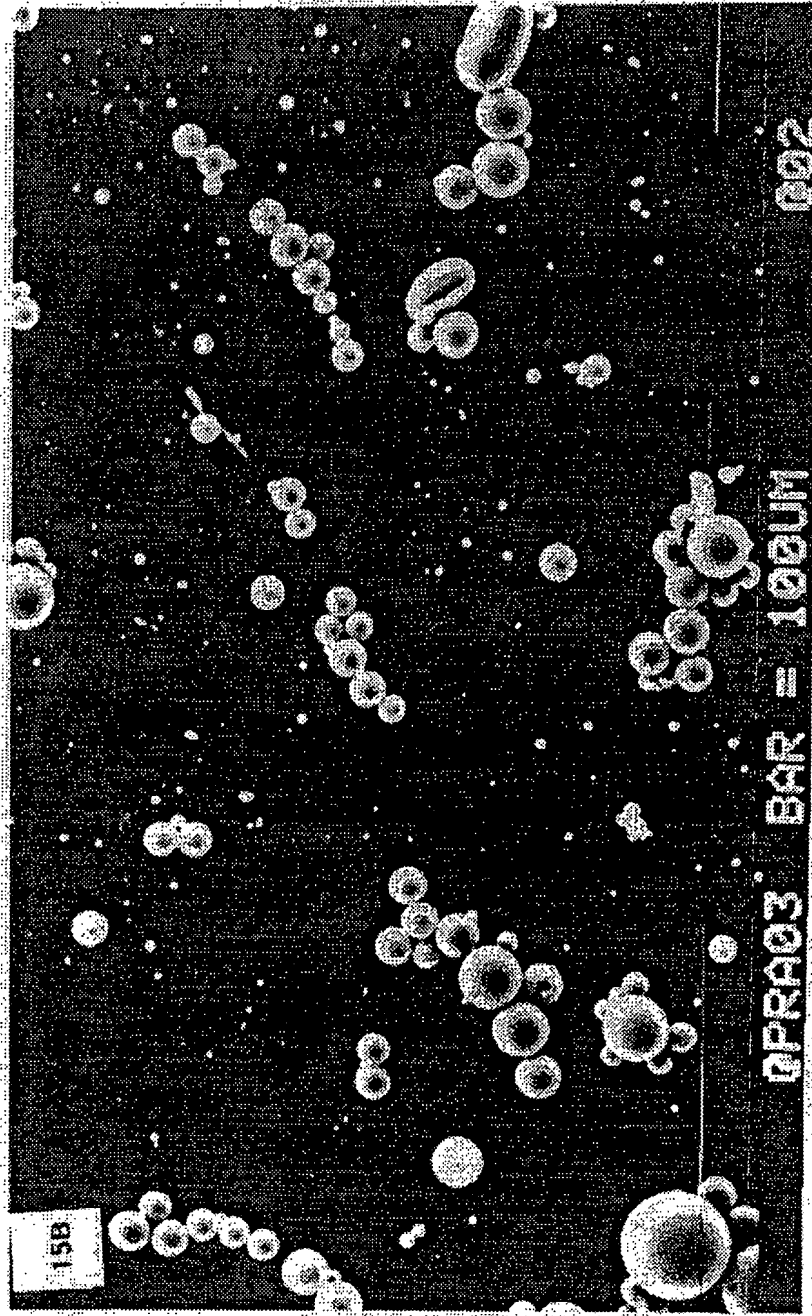

FIG. 15B

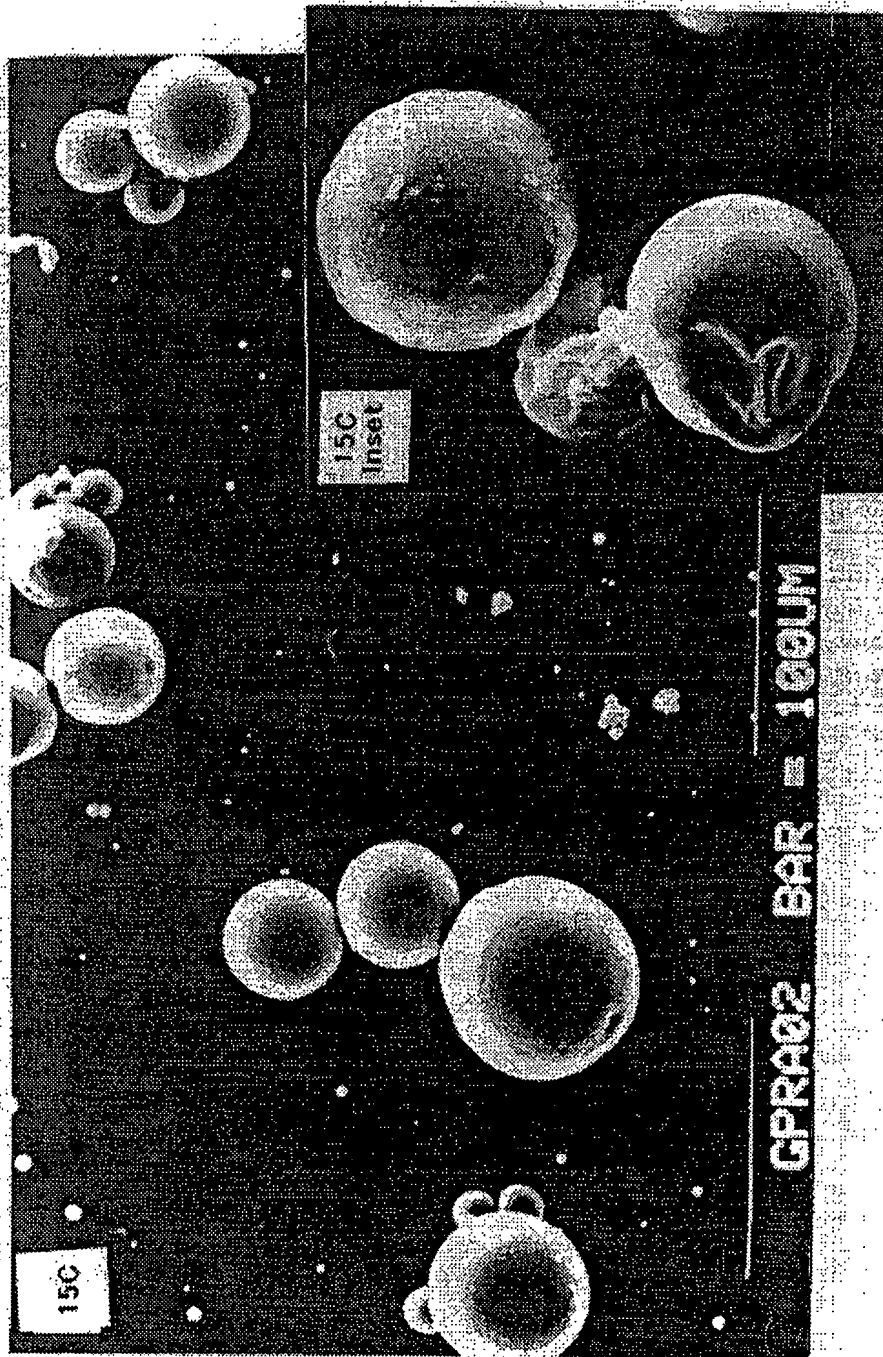

FIG. 15C

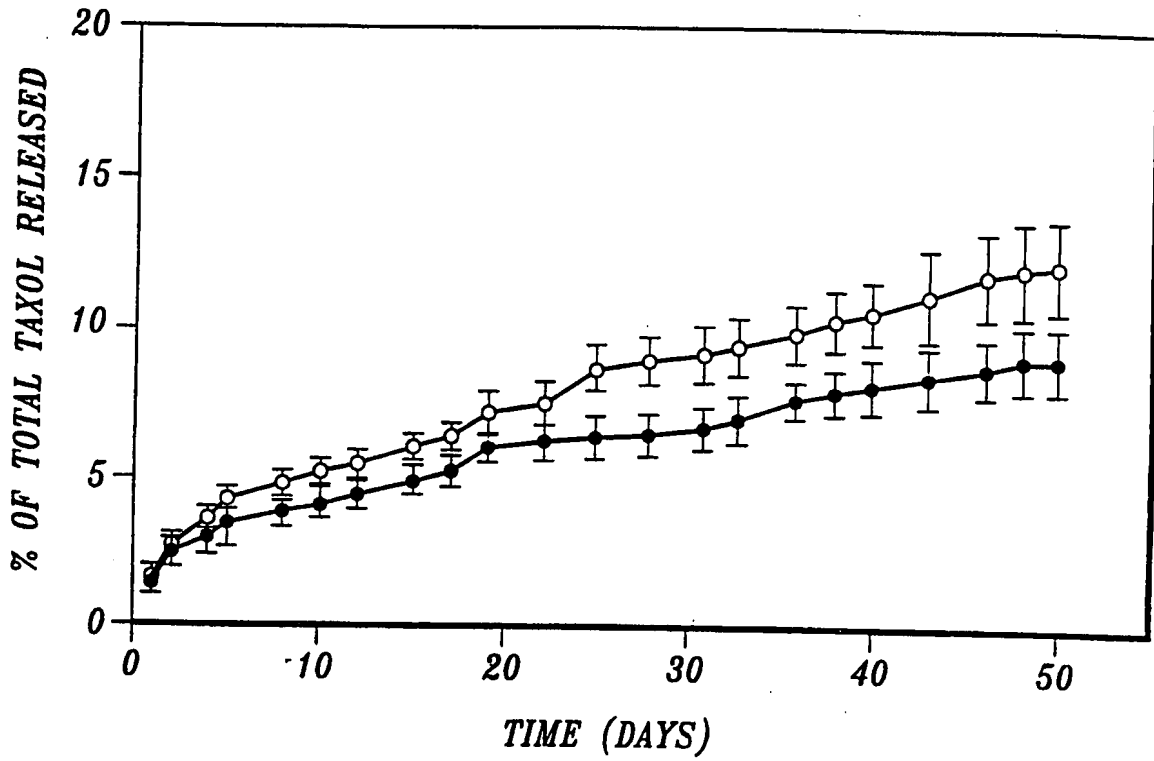

FIG. 15D.

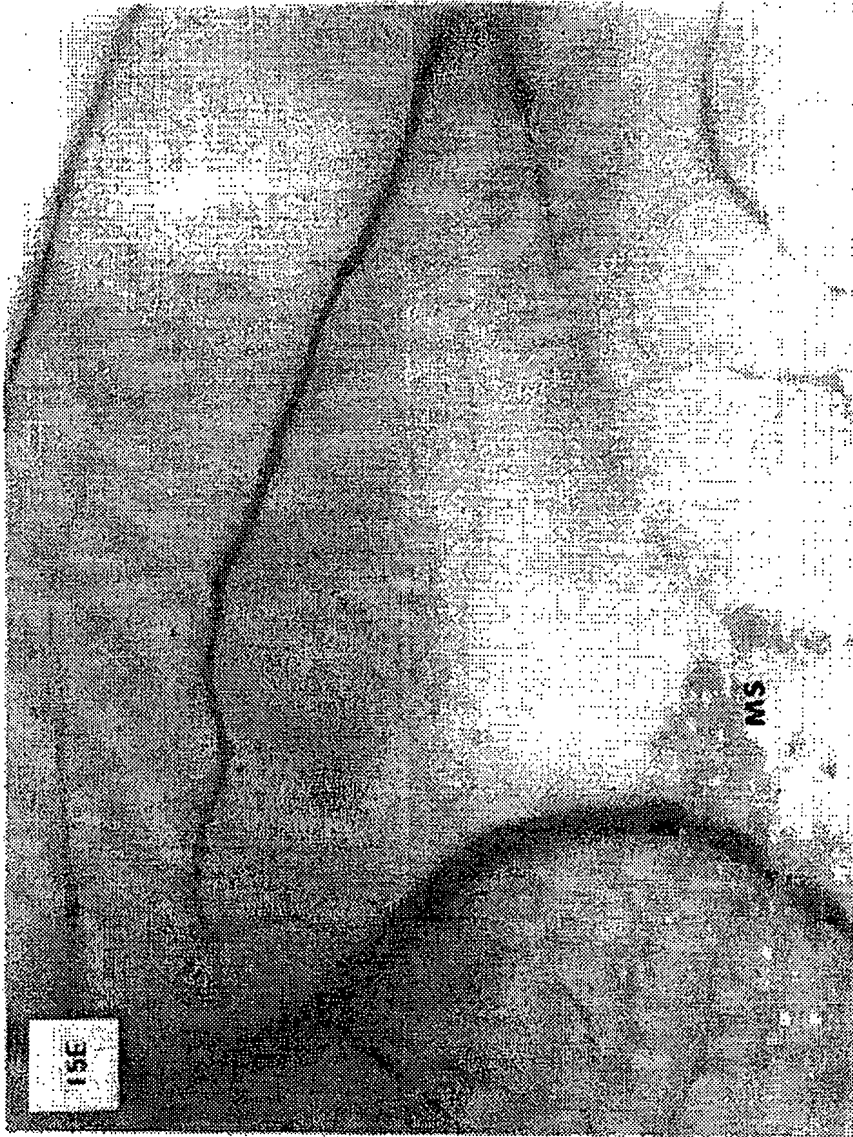
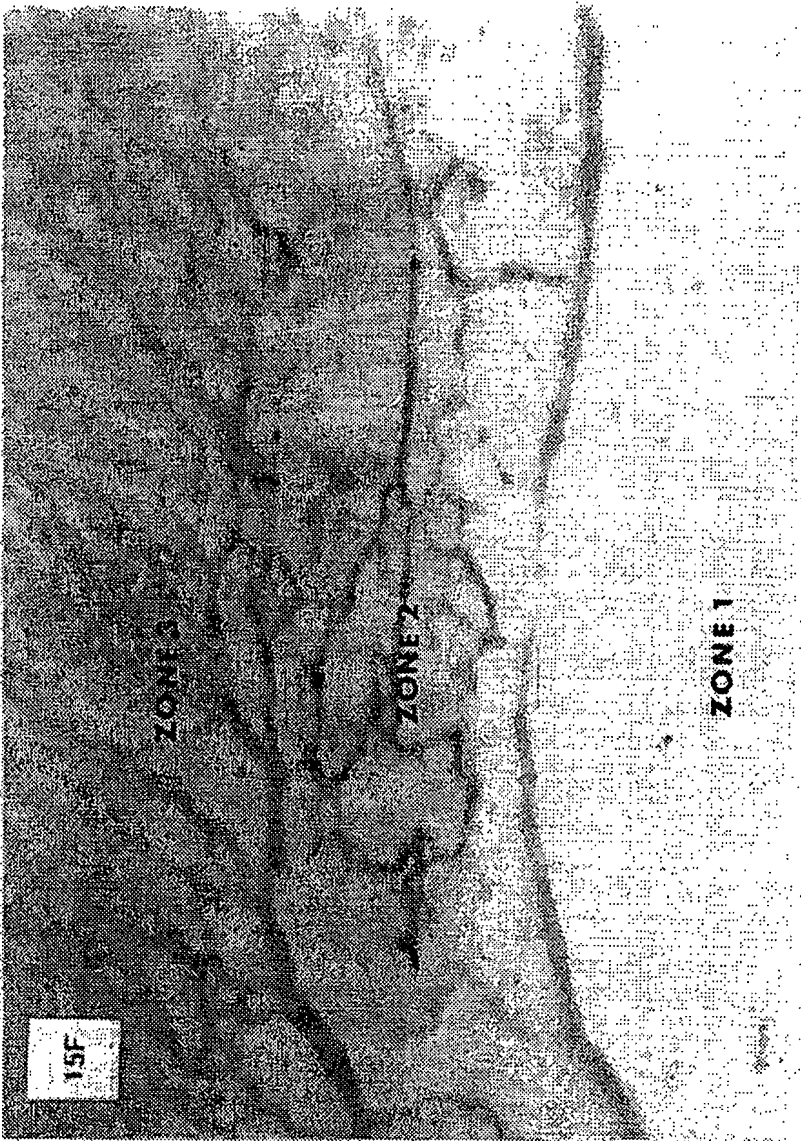

FIG. 15E



MS

FIG. 15F

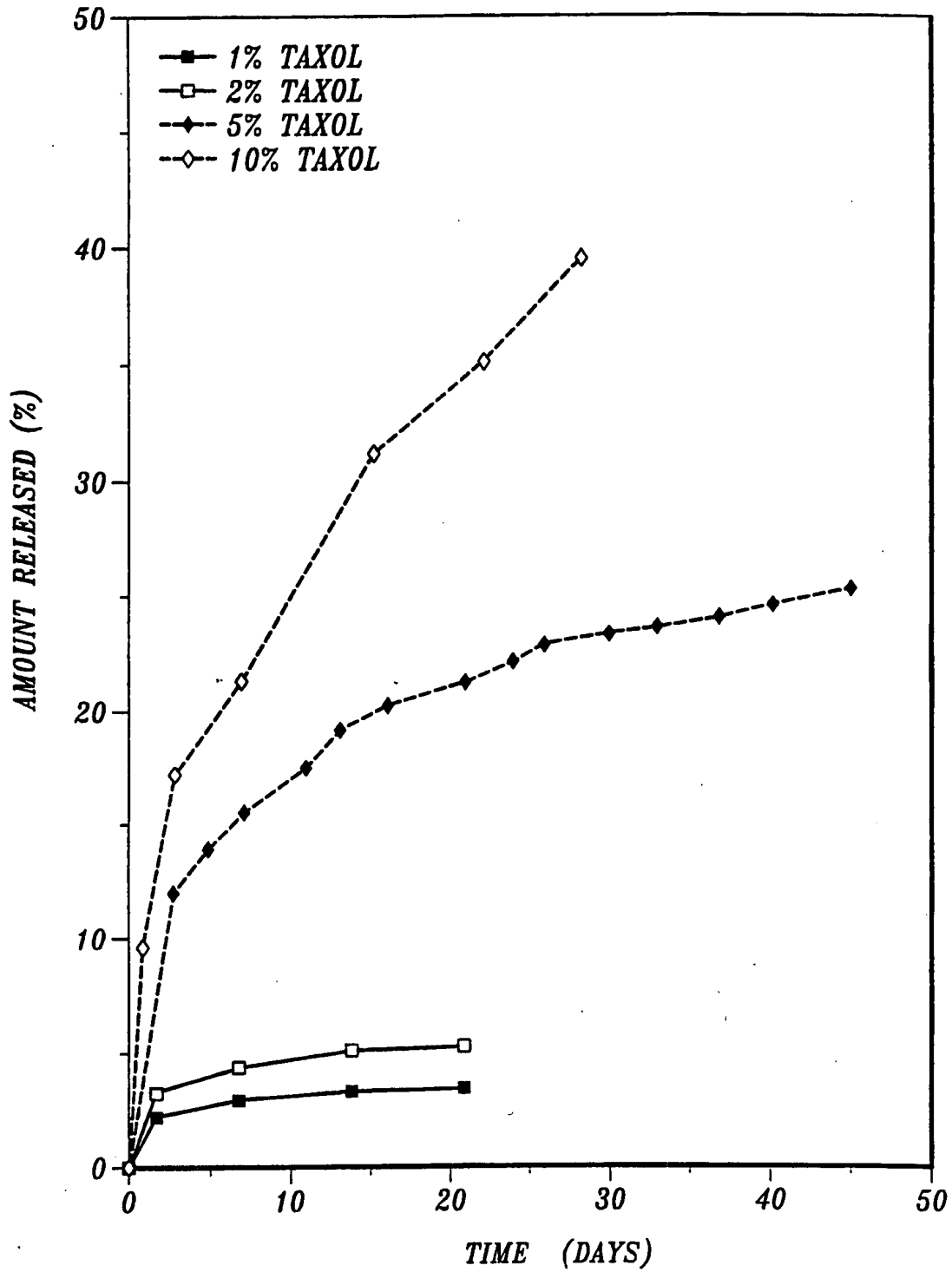

FIG. 16A.

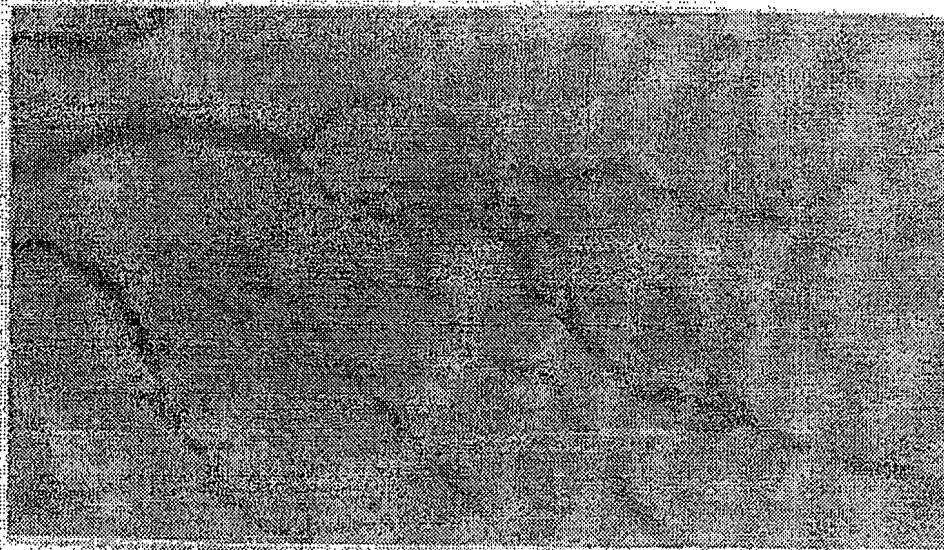

FIG. 16B

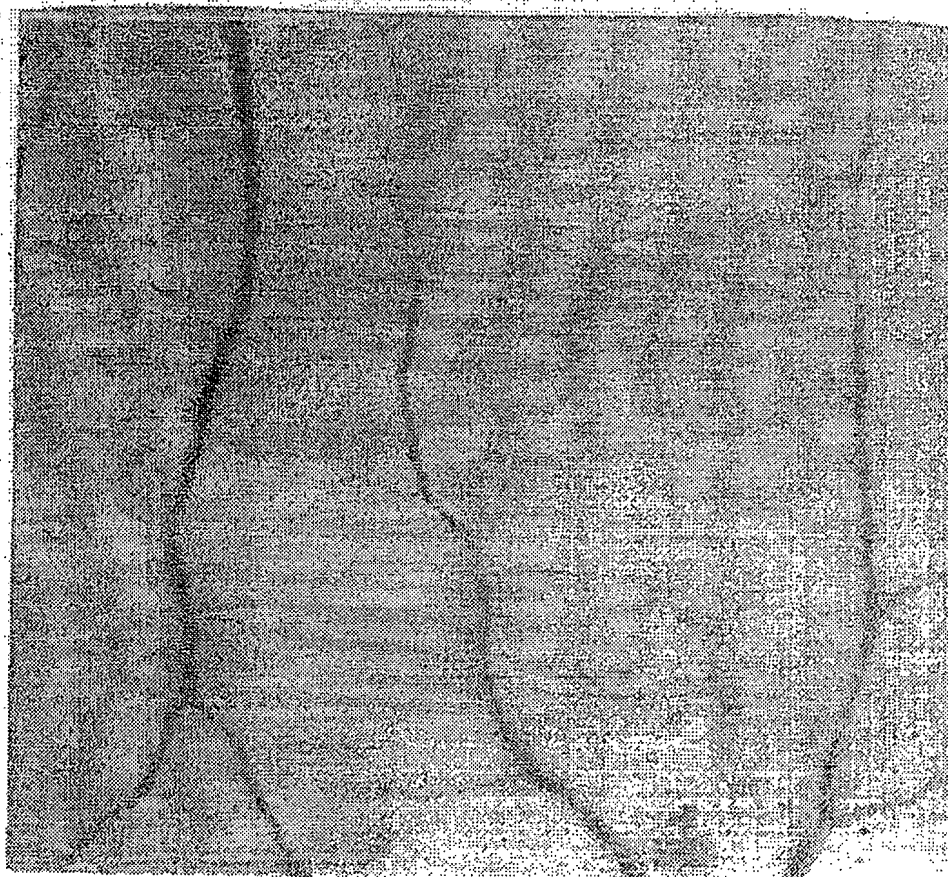

FIG. 16C

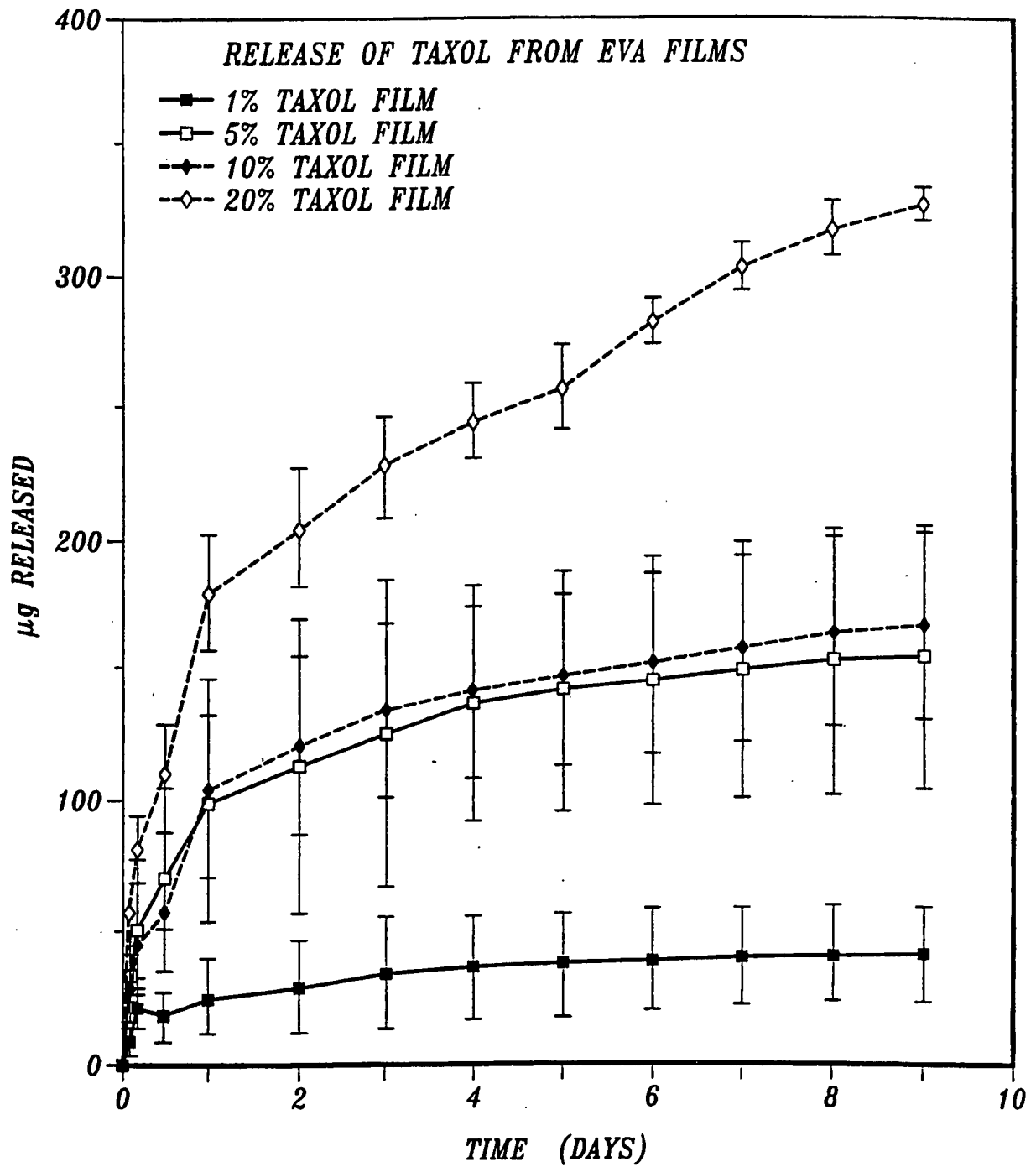

FIG. 17A.

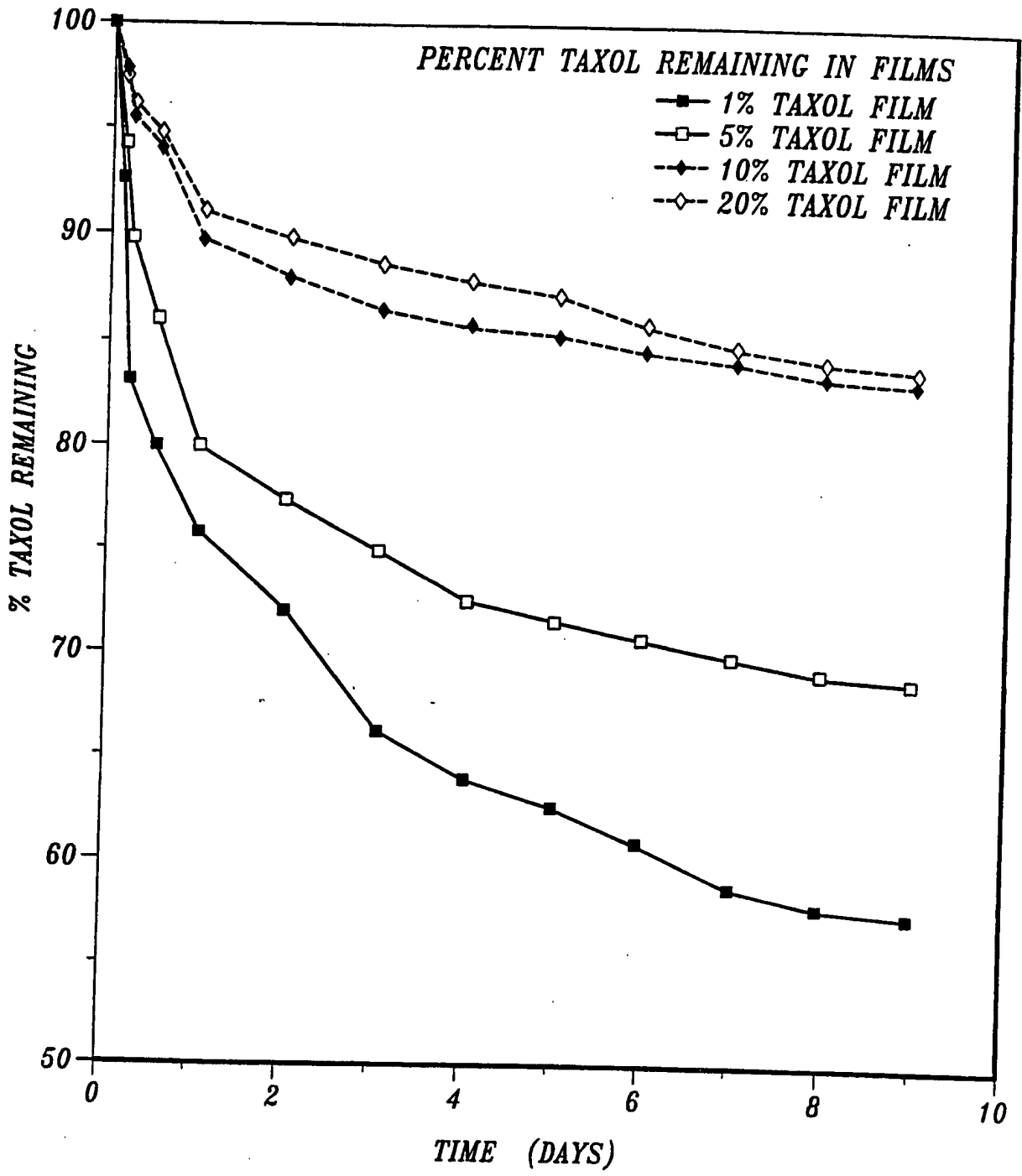

FIG. 17B.

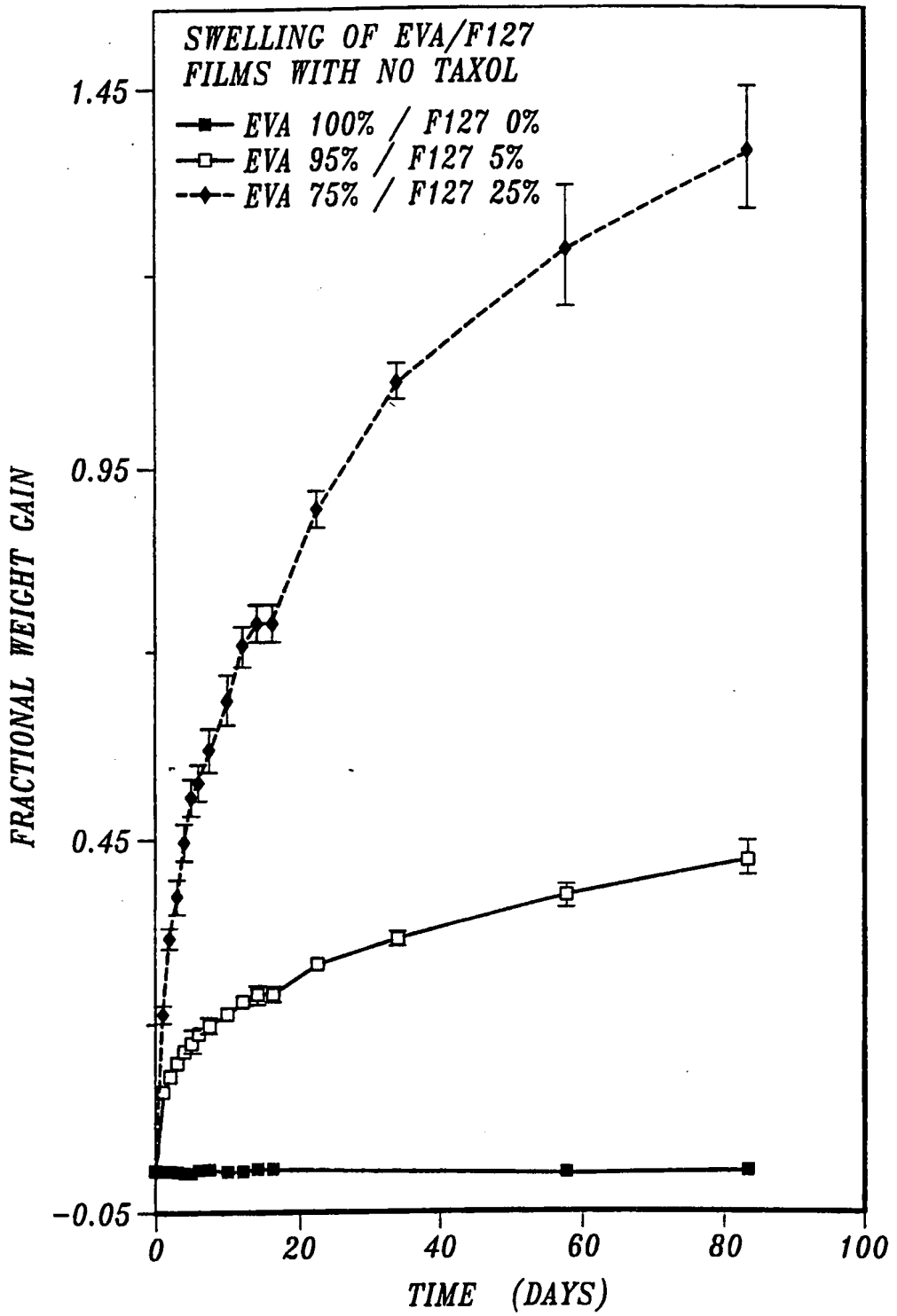

FIG. 17C.

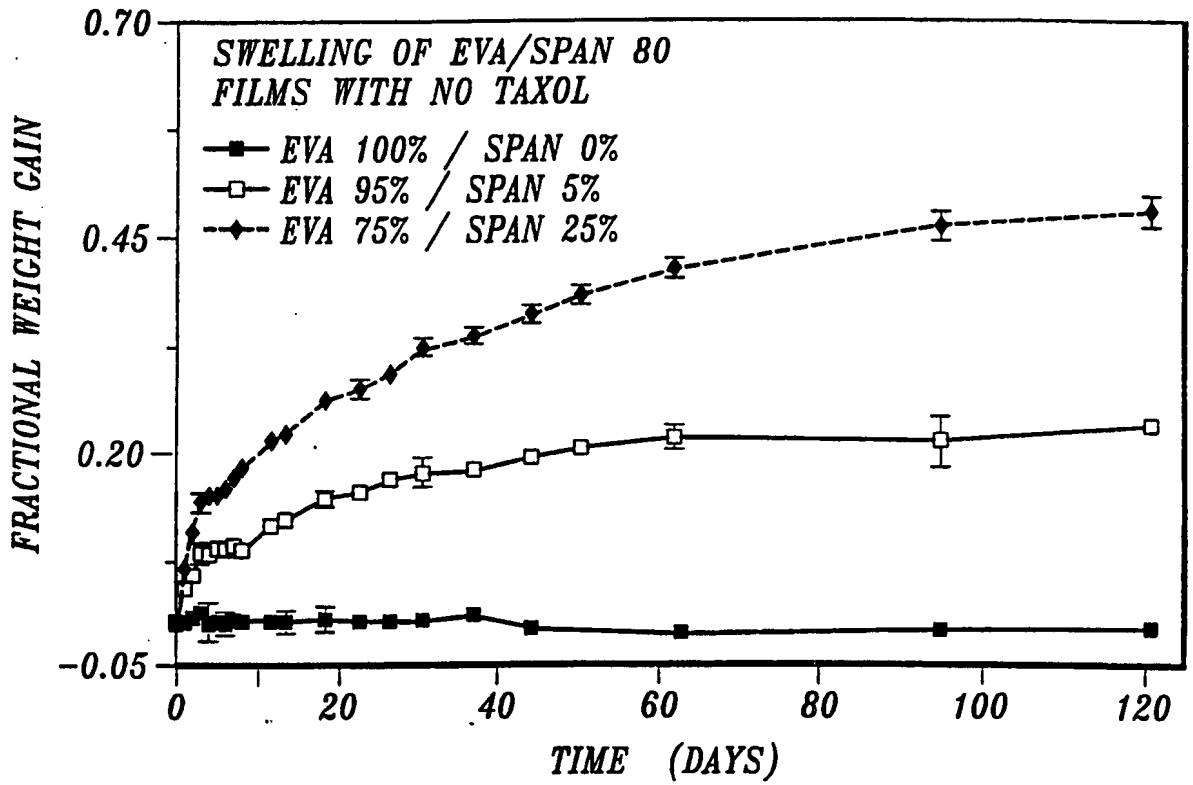

FIG. 17D.

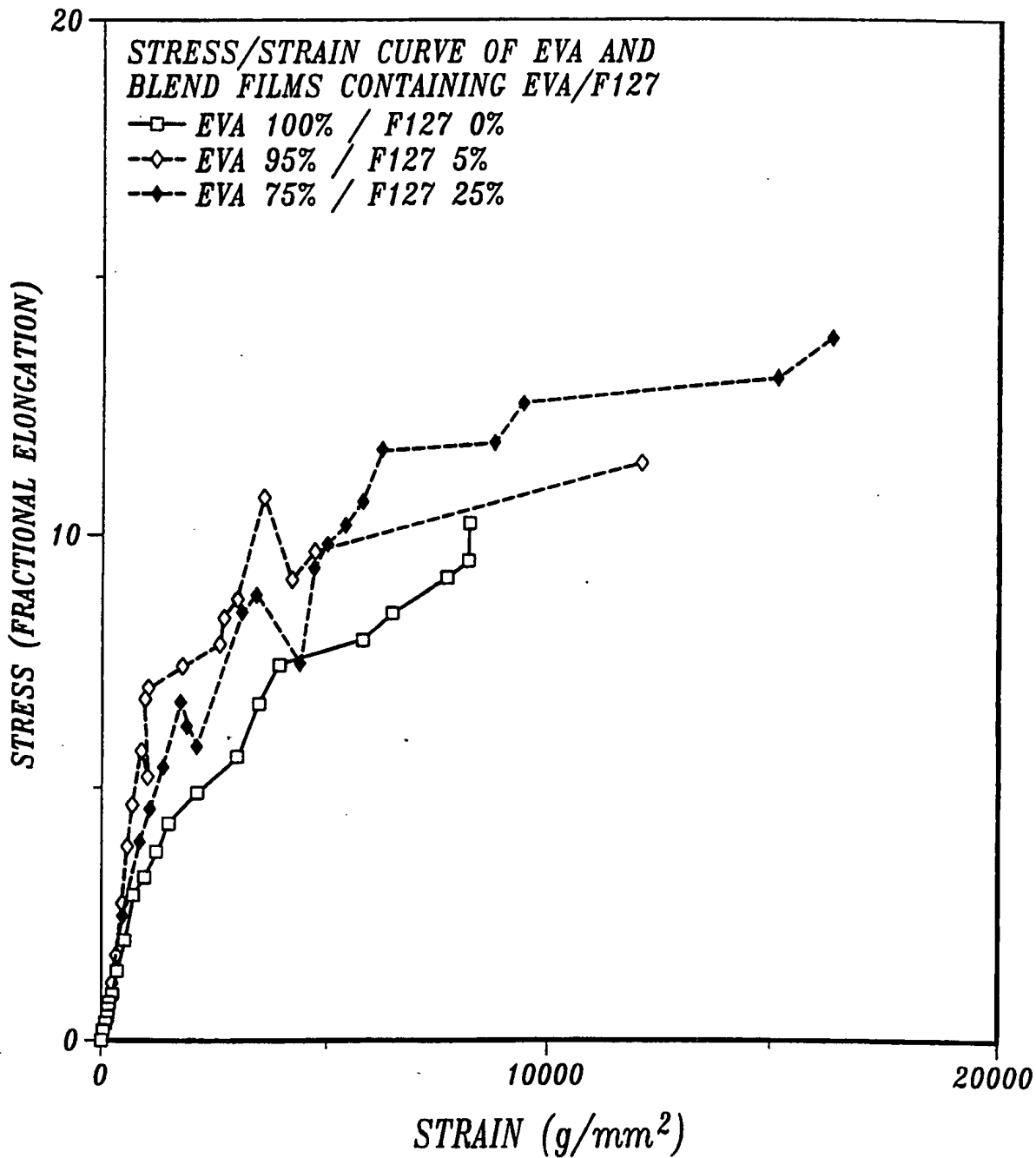

FIG. 17E.

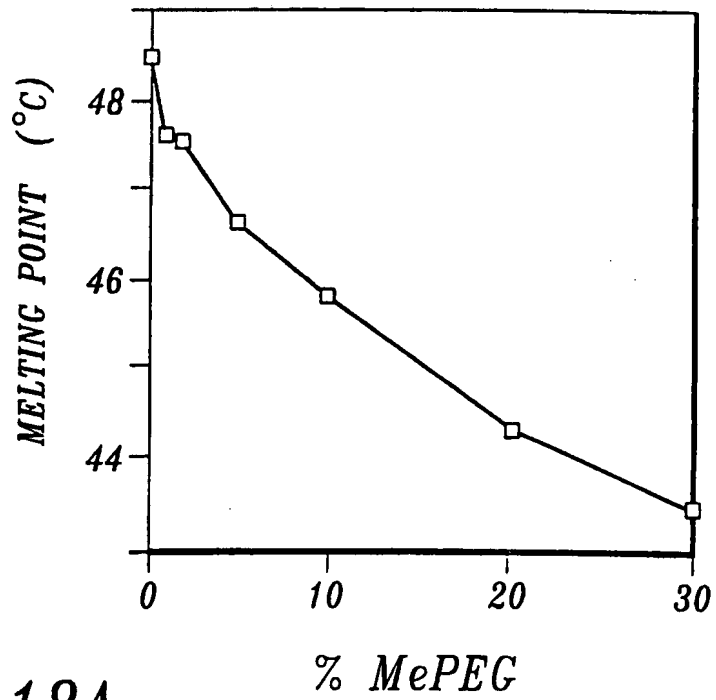

FIG. 18A.

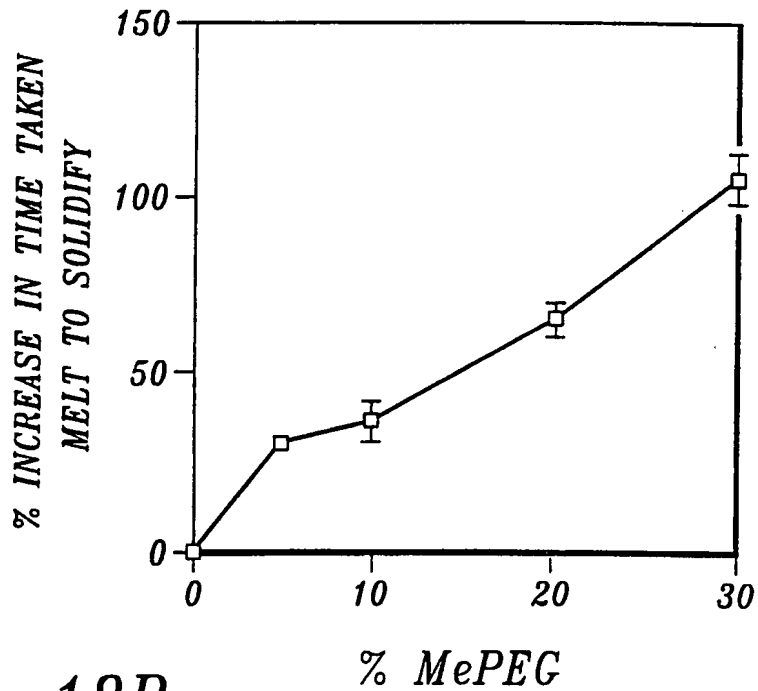

FIG. 18B.

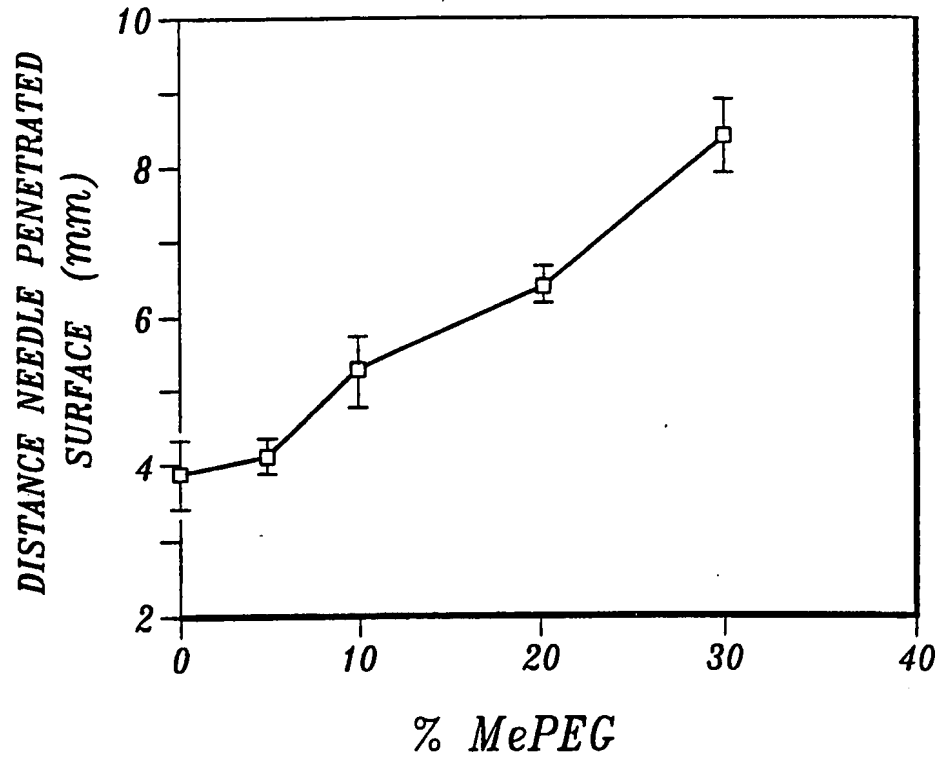

FIG. 18C.

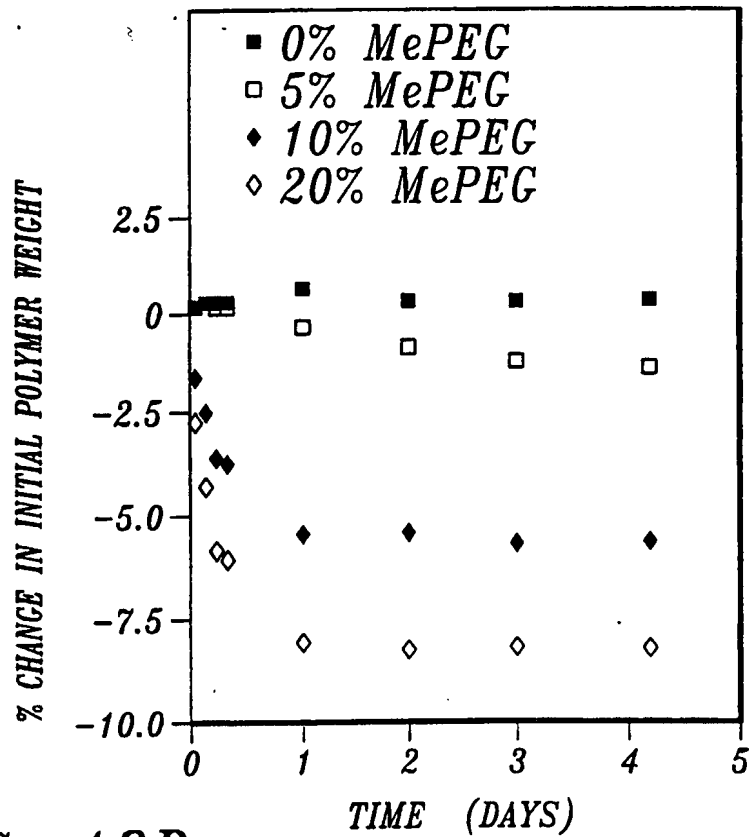

FIG. 18D.

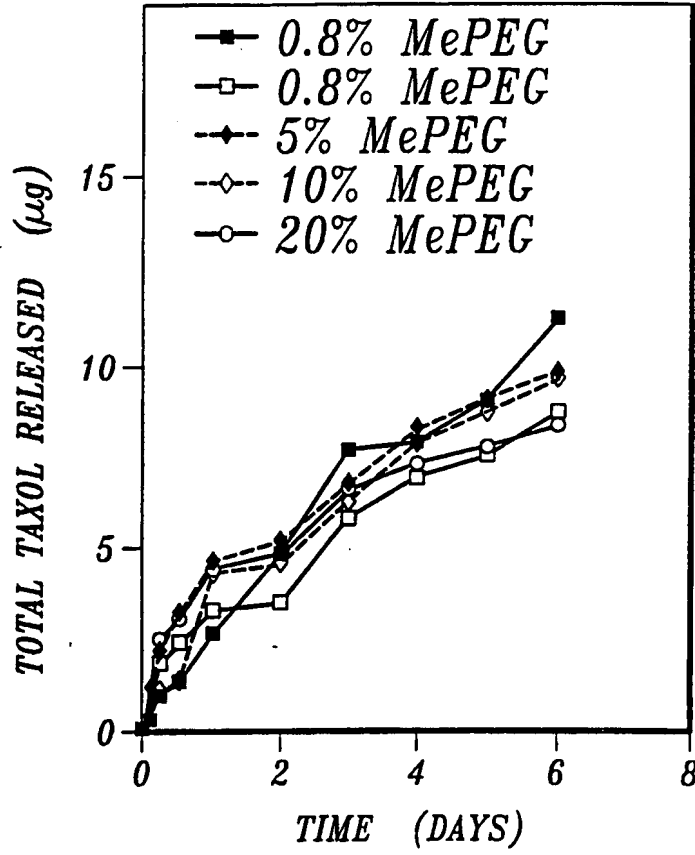

FIG. 18E.

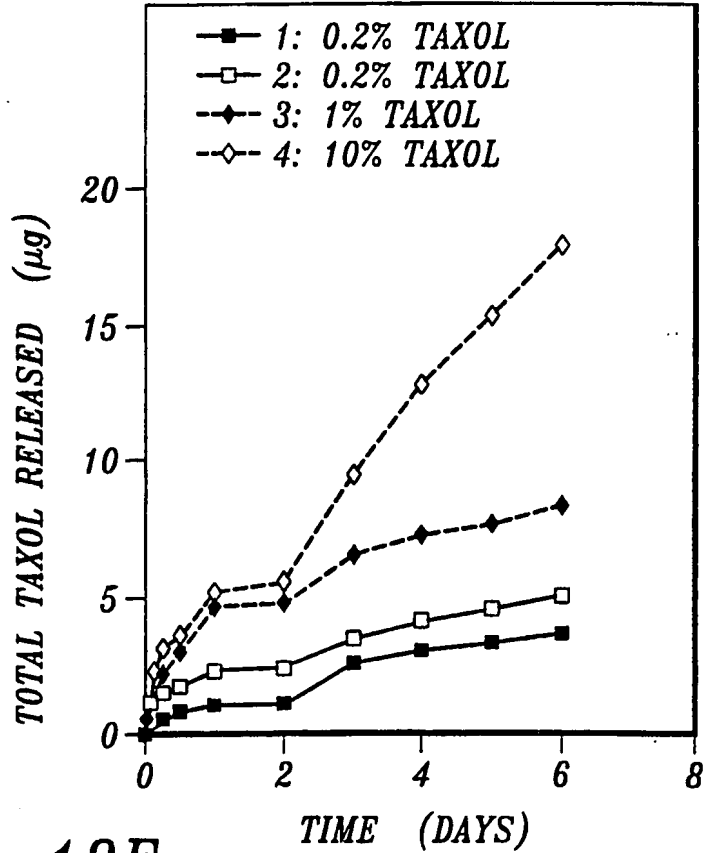

FIG. 18F.

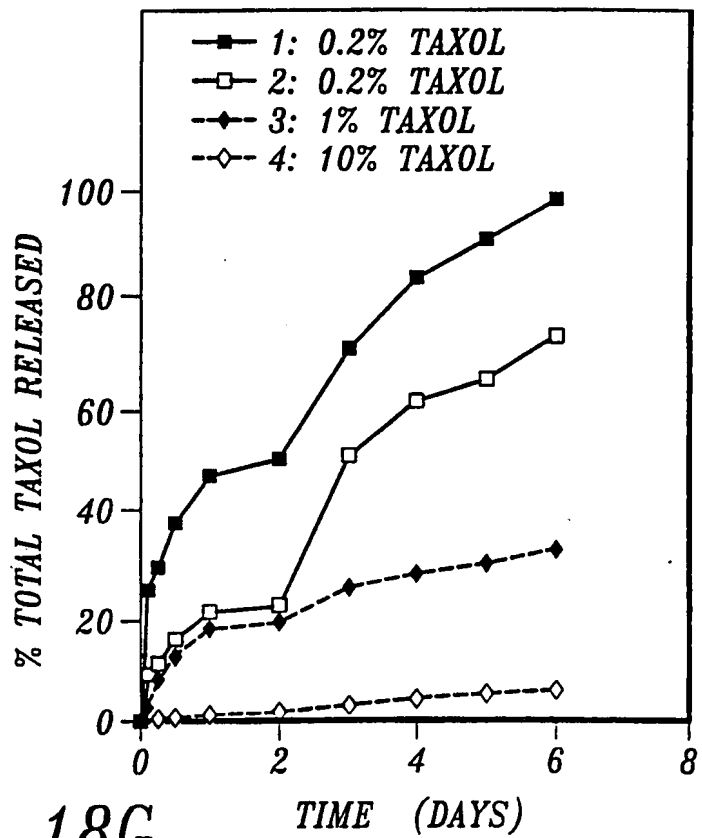

FIG. 18G.

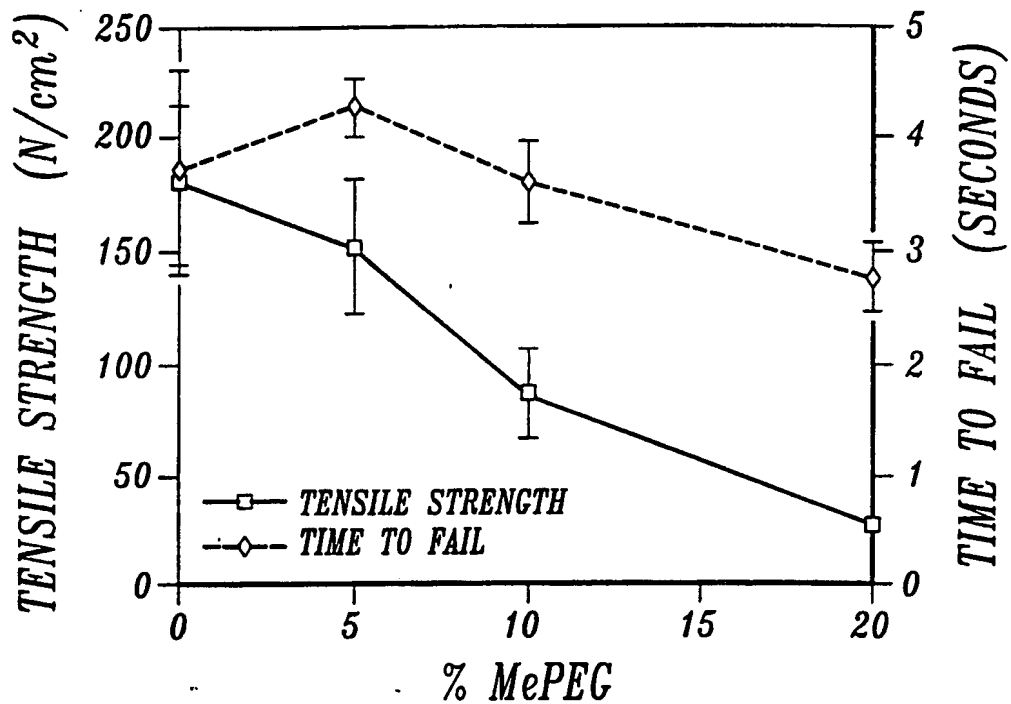

FIG. 18H.



FIG. 19A

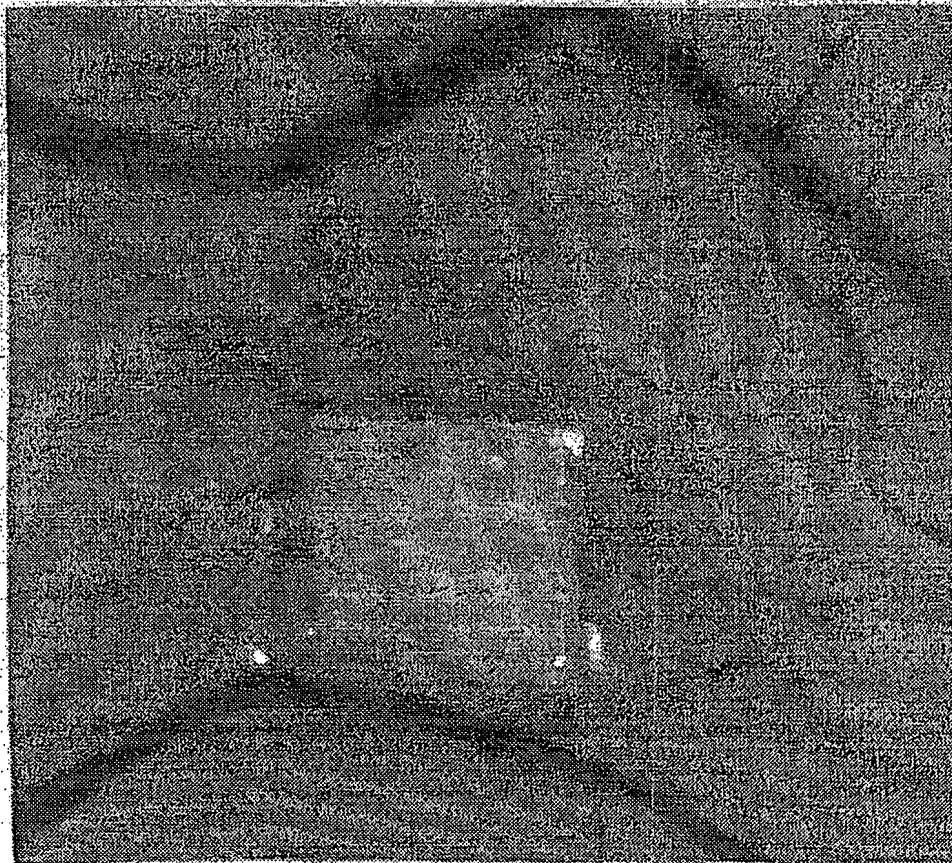

FIG. 19B

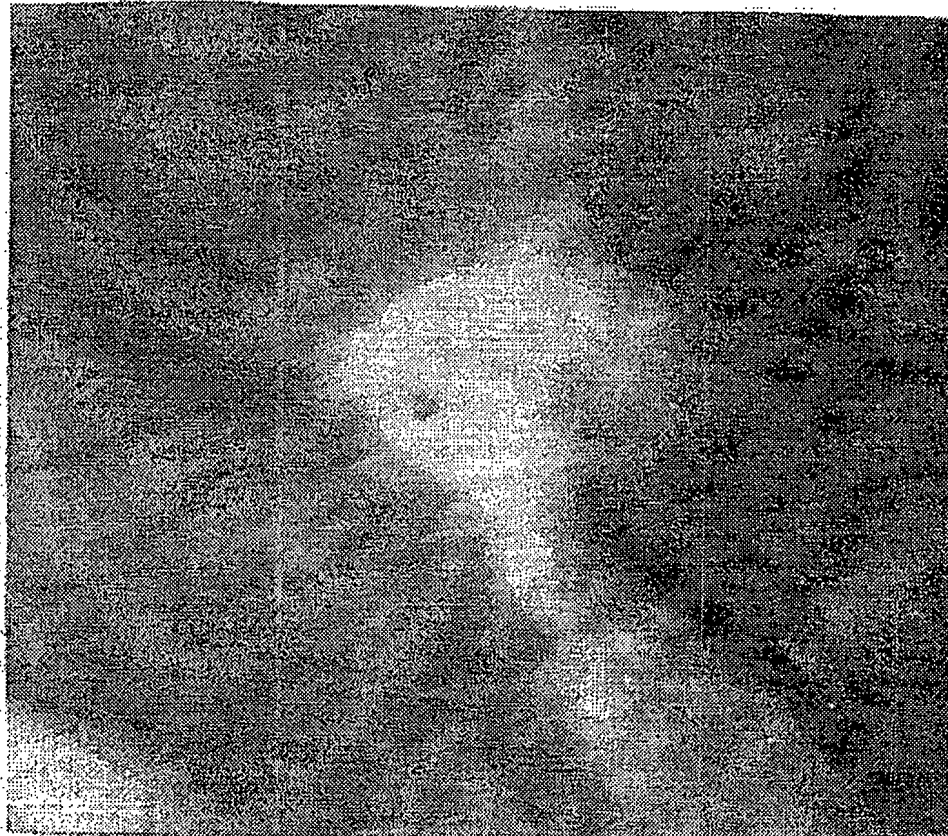

FIG. 20A



FIG. 20B

SUBSTITUTE SHEET

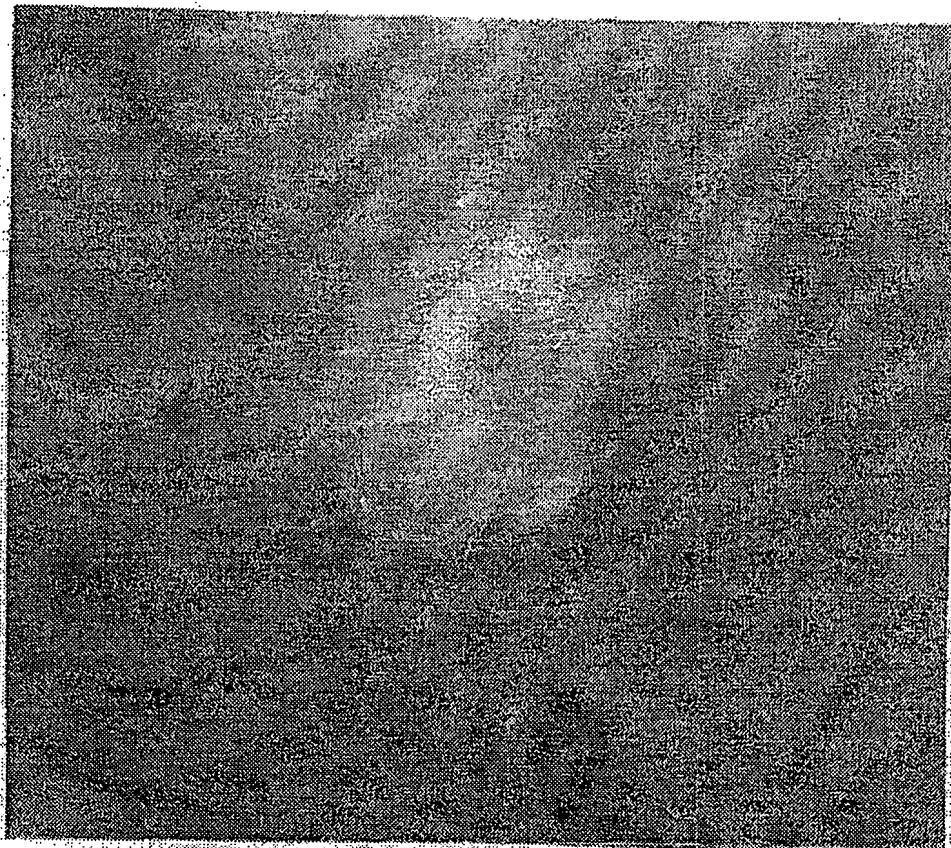

FIG. 20C



FIG. 20D

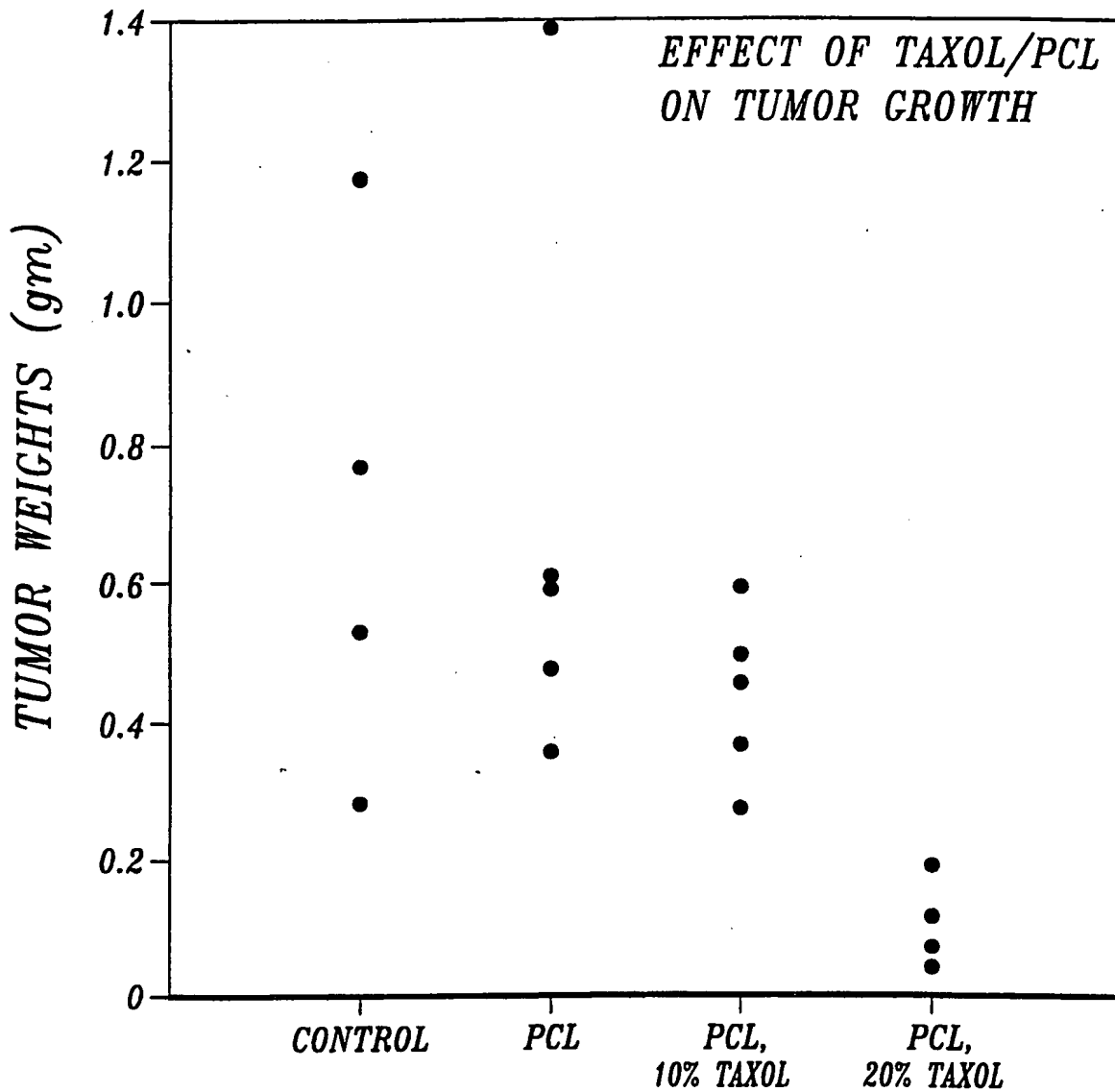

FIG. 21A.

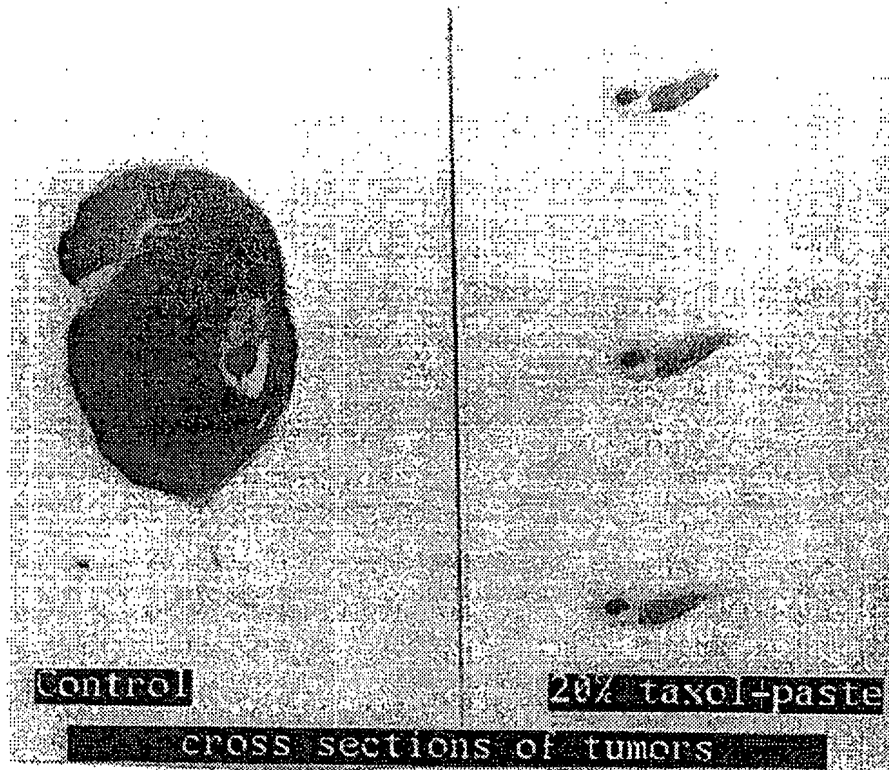

FIG. 21B

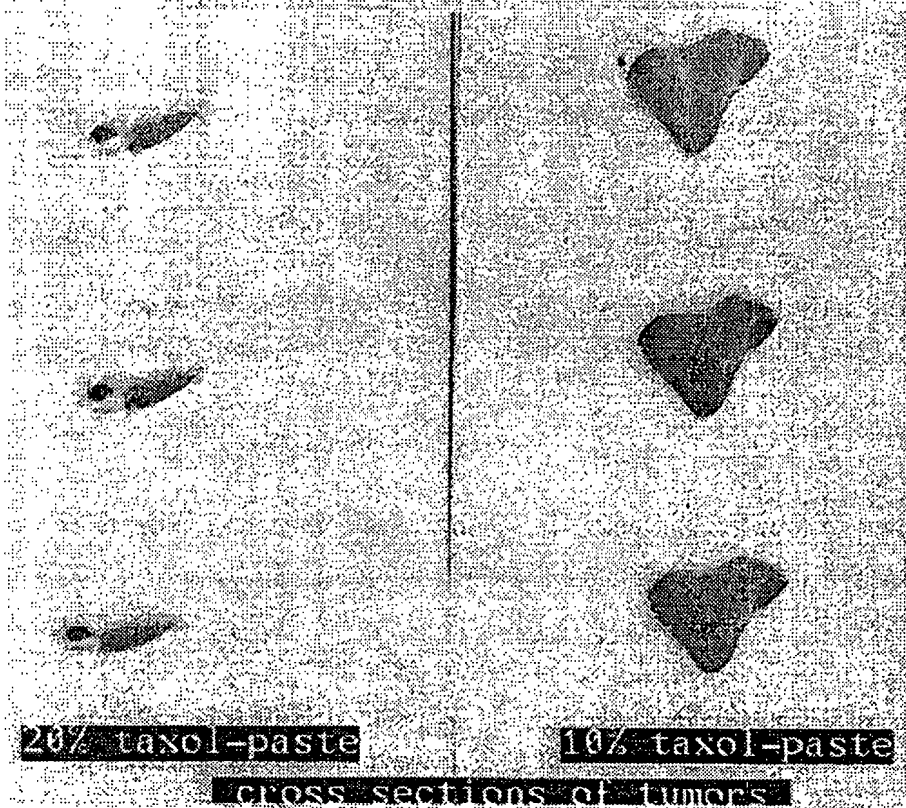

FIG. 21C

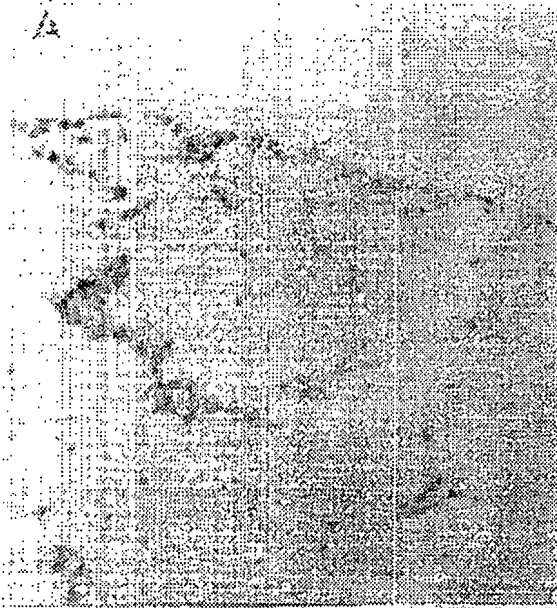

FIG. 22A

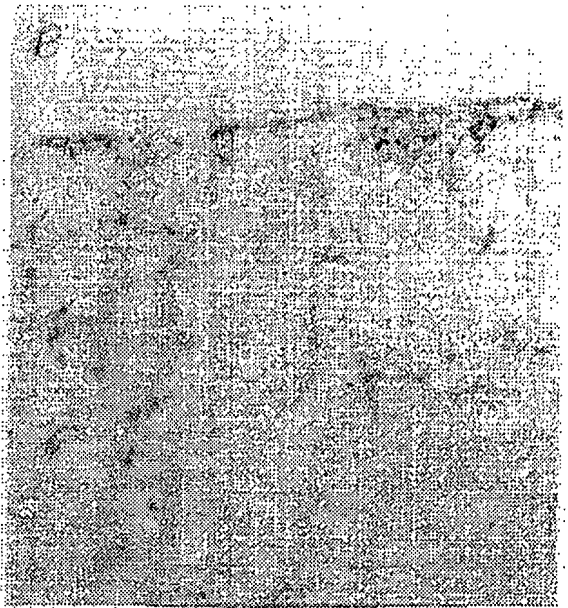

FIG. 22B



FIG. 22C

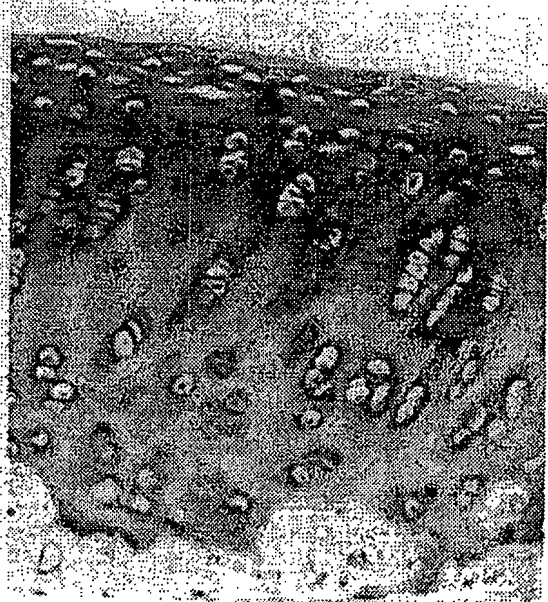

FIG. 22D

A. CLASSIFICATION OF SUBJECT MATTER
 IPC 6 A61K9/16 A61K9/70 A61L31/00 A61K31/20 A61K31/335
 A61K38/57

According to International Patent Classification (IPC) or to both national classification and IPC

B. FIELDS SEARCHED

Minimum documentation searched (classification system followed by classification symbols)
 IPC 6 A61K A61L

Documentation searched other than minimum documentation to the extent that such documents are included in the fields searched

Electronic data base consulted during the international search (name of data base and, where practical, search terms used)

C. DOCUMENTS CONSIDERED TO BE RELEVANT

Category *	Citation of document, with indication, where appropriate, of the relevant passages	Relevant to claim No.
X	EP,A,0 470 569 (TAKEDA CHEMICAL INDUSTRIES, LTD.) 12 February 1992 see the whole document ---	1,6,8, 10-16
X	WO,A,91 11193 (CHILDREN'S HOSPITAL) 8 August 1991	1,2,4
Y	see page 1, line 8 - page 6, line 21 see page 27, line 27 - line 34 see claims 11,23 ---	17-23, 31-35
X	WO,A,91 10424 (NORTHWESTERN UNIVERSITY) 25 July 1991 see page 1, line 1 - line 3 see page 13, line 12 - line 23 see page 19 - page 20; examples 7,8 --- -/--	1,6,9,24

Further documents are listed in the continuation of box C. Patent family members are listed in annex.

* Special categories of cited documents :

<p>'A' document defining the general state of the art which is not considered to be of particular relevance</p> <p>'E' earlier document but published on or after the international filing date</p> <p>'L' document which may throw doubts on priority claim(s) or which is cited to establish the publication date of another citation or other special reason (as specified)</p> <p>'O' document referring to an oral disclosure, use, exhibition or other means</p> <p>'P' document published prior to the international filing date but later than the priority date claimed</p>	<p>'T' later document published after the international filing date or priority date and not in conflict with the application but cited to understand the principle or theory underlying the invention</p> <p>'X' document of particular relevance; the claimed invention cannot be considered novel or cannot be considered to involve an inventive step when the document is taken alone</p> <p>'Y' document of particular relevance; the claimed invention cannot be considered to involve an inventive step when the document is combined with one or more other such documents, such combination being obvious to a person skilled in the art.</p> <p>'&' document member of the same patent family</p>
--	--

Date of the actual completion of the international search 22 December 1994	Date of mailing of the international search report 30.12.94
---	--

Name and mailing address of the ISA European Patent Office, P.B. 5818 Patentlaan 2 NL - 2280 HV Rijswijk Tel. (+31-70) 340-2040, Tx. 31 651 epo nl, Fax: (+31-70) 340-3016	Authorized officer Benz, K
--	-----------------------------------

C.(Continuation) DOCUMENTS CONSIDERED TO BE RELEVANT		
Category *	Citation of document, with indication, where appropriate, of the relevant passages	Relevant to claim No.
X	EP,A,0 375 520 (CENTRE INTERNATIONAL DE RECHERCHES DERMATOLOGIQUES C.I.R.D.) 27 June 1990 see page 12; example 10 ---	1,3
P,X	CANCER RESEARCH, vol.54, 15 April 1994, BALTIMORE, MD(US) pages 2207 - 2212 K.A. WALTER ET AL. 'interstitial taxol delivered from a biodegradable polymer implant against experimental malignant glioma' Y see page 2210, column 2, line 14 - line 21 ---	1,5, 27-30, 38,39
X	JOURNAL OF MICROENCAPSULATION, vol.7, no.2, May 1990, LONDON (GB) pages 191 - 197 M.-H. BARTOLI 'in vitro and in vivo antitumoral activity of free and encapsulated taxol' A see the whole document ---	5
A	WO,A,92 12717 (BREM ET AL.) 6 August 1992 see page 1, line 1 - line 2 see page 9, line 15 - line 30 ---	25,26
A	WO,A,92 12717 (BREM ET AL.) 6 August 1992 see page 1, line 1 - line 2 see page 9, line 15 - line 30 ---	1-14
P,X	EP,A,0 567 816 (BEHRINGWERKE AKTIENGESELLSCHAFT) 3 November 1993 see claims 1,3,4,18,19 ---	1,4
Y	WO,A,92 15286 (NOVA PHARMACEUTICAL CORPORATION) 17 September 1992 see the whole document -----	17-23, 31-36

Box I Observations where certain claims were found unsearchable (Continuation of item 1 of first sheet)

This international search report has not been established in respect of certain claims under Article 17(2)(a) for the following reasons:

1. Claims Nos.: 15, 16, 18-38
because they relate to subject matter not required to be searched by this Authority, namely:
Remark: Although claims 15, 16, 18-38 are directed to a method of
treatment of the human/animal body, the search has been carried
out and based on the alleged effects of the compound/composition.
2. Claims Nos.:
because they relate to parts of the international application that do not comply with the prescribed requirements to such
an extent that no meaningful international search can be carried out, specifically:
3. Claims Nos.:
because they are dependent claims and are not drafted in accordance with the second and third sentences of Rule 6.4(a).

Box II Observations where unity of invention is lacking (Continuation of item 2 of first sheet)

This International Searching Authority found multiple inventions in this international application, as follows:

1. As all required additional search fees were timely paid by the applicant, this international search report covers all
searchable claims.
2. As all searchable claims could be searched without effort justifying an additional fee, this Authority did not invite payment
of any additional fee.
3. As only some of the required additional search fees were timely paid by the applicant, this international search report
covers only those claims for which fees were paid, specifically claims Nos.:
4. No required additional search fees were timely paid by the applicant. Consequently, this international search report is
restricted to the invention first mentioned in the claims; it is covered by claims Nos.:

Remark on Protest

- The additional search fees were accompanied by the applicant's protest.
- No protest accompanied the payment of additional search fees.

Patent document cited in search report	Publication date	Patent family member(s)	Publication date
EP-A-0470569	12-02-92	CA-A- 2048544	09-02-92
		JP-A- 5000969	08-01-93
		US-A- 5202352	13-04-93
WO-A-9111193	08-08-91	AU-B- 652744	08-09-94
		AU-A- 7335191	21-08-91
		EP-A- 0512071	11-11-92
		JP-T- 6509791	02-11-94
WO-A-9110424	25-07-91	US-A- 5192744	09-03-93
		EP-A- 0463152	02-01-92
		JP-T- 4504429	06-08-92
EP-A-0375520	27-06-90	LU-A- 87410	10-07-90
		AU-B- 626619	06-08-92
		AU-A- 4709989	28-06-90
		CA-A- 2006028	20-06-90
		DE-T- 68905914	14-10-93
		ES-T- 2054069	01-08-94
		JP-A- 3135913	10-06-91
		US-A- 5292512	08-03-94
WO-A-9212717	06-08-92	AU-A- 1411992	27-08-92
EP-A-0567816	03-11-93	DE-A- 4214215	04-11-93
		AU-B- 3822993	04-11-93
		CZ-A- 9300768	19-01-94
		HU-A- 65755	28-07-94
		JP-A- 6009425	18-01-94
		PL-A- 298748	27-12-93
WO-A-9215286	17-09-92	AU-A- 1579092	06-10-92
		US-A- 5344411	06-09-94